

Date: \_\_\_\_\_ Customer: \_\_\_\_\_

Project: \_\_\_\_\_

Type: \_\_\_\_\_ Qty: \_\_\_\_\_



# Piix™ MRC LED Linear Recessed



Order Code: \_\_\_\_\_

Series	<b>PXLR</b> Piix™ MRC (Micro Reflector Cell) Multi-Mount Form LED Linear Recessed		<b>PXLR1</b> Piix™ MRC (Micro Reflector Cell) Continuous Flange (Flanged Endcaps) LED Linear Recessed		<b>PXLR2</b> Piix™ MRC (Micro Reflector Cell) Continuous Flange (Flangeless Endcaps) LED Linear Recessed		
Light Engine	<b>1B45</b> 1150lm/10.9W per foot	<b>1B40</b> 1045lm/9.7W per foot	<b>1B30</b> 803lm/7.4W per foot	<b>1B20</b> 543lm/4.9W per foot	*Values calculated from a 4' fixture at 4000K, 90+CRI using 35° (wide) reflector, no secondary optics, and DIM driver.		
CCT	<b>927</b> 2700K 90+CRI	<b>930</b> 3000K 90+CRI	<b>935</b> 3500K 90+CRI	<b>940</b> 4000K 90+CRI			
Optics	<b>10</b> 10° Very Narrow (beam angle 20°)	<b>20</b> 20° Narrow (beam angle 40°)	<b>35</b> 35° Medium (beam angle 70°)	<b>50</b> 50° Wide (beam angle 100°)			
Secondary Optics	<b>CL</b> Clear Lens (defined edge)	<b>DF</b> 30% Diffuse Lens (soft edge)	<b>LF</b> 5% Lightly Diffuse Lens (soft edge)	<b>HX</b> Hexcell Louver	<b>XX</b> No Secondary Optics (defined edge)		
Baffle Finish	<b>PW</b> Matte White	<b>PB</b> Matte Black					
Mounting PXLR or Mounting PXLR1/2	<b>SF1</b> Spackle Flange (½" Drywall)	<b>SF2</b> Spackle Flange (¾" Drywall)	<b>SF3</b> Spackle Flange (After Drywall)	<b>SG</b> Slot Grid (¾") (Wire Suspension or ¼"-20 stud)	<b>DC</b> Decoustic Ceiling (up to 2" thick)		
	<b>TB<sup>1</sup></b> T-Bar Length w/ Suspension Clips	<b>TBS<sup>1</sup></b> T-Bar Length w/ 1" ¼"-20 Stud	<b>PMT<sup>1</sup></b> T-Bar Length Perimeter Mount	<b>RC</b> Rotating Crossbar (Ceilings ¼" to 2" thick)	<b>TS</b> 1" ¼"-20 Stud	<b>PM</b> Perimeter Mount	
Nominal Fixture Length	<b>02</b> 2 ft.	<b>03<sup>2</sup></b> 3 ft.	<b>04</b> 4 ft.	<b>05</b> 5 ft.	<b>06</b> 6 ft.	<b>07<sup>2</sup></b> 7 ft.	
						<b>08</b> 8 ft.	<b>XX</b> For luminaires with OAL > 8 ft, round up to the nearest foot and replace the "xx" with the #, Notes exact OAL on fixture schedule. For luminaires with OAL < 8ft, please consult factory.
Finish	<b>WH</b> White	<b>BL</b> Semi-Matte Black	<b>SV</b> Silver	<b>SP</b> Specify Premium Color			
	* Custom colors are available, please consult factory						
Voltage	<b>1</b> 120V	<b>2</b> 277V	<b>U</b> 120V through 277V 50/60Hz capable		<b>3</b> 347V (consult factory)		
Driver	<b>DIM<sup>3</sup></b> 0-10V 1% (Linear)	<b>DIL<sup>3</sup></b> eldoLED 1% ECOdrive 0-10V (Logarithmic)	<b>DED<sup>3</sup></b> eldoLED 1% ECOdrive DALI-2 (Logarithmic)	<b>D01<sup>3</sup></b> eldoLED 0.1% SOLOdrive 0-10V (Linear)	<b>DL01<sup>3</sup></b> eldoLED 0.1% SOLOdrive 0-10V (Logarithmic)	<b>DE1<sup>3</sup></b> Lutron 1% EcoSystem	
						<b>DC3</b> Lutron 1% 3-Wire (consult factory)	
	* See page 7 for full details						
Fixture Options	<b>FS</b> In-line Fuse	<b>SS</b> Separate Switching					
Sensor Options	<b>xE</b> Enlighted (consult factory)	<b>xS1<sup>4,5</sup></b> Sensor Switch Daylight	<b>xS2<sup>4,5</sup></b> Sensor Switch Occ/Vac	<b>xS3<sup>4,5</sup></b> Sensor Switch Occ/Vac/ Daylight	<b>xSN</b> nLight Enabled (consult factory)	<b>xV</b> Lutron Vive (consult factory)	
	Replace "x" with quantity						
Emergency Options	<b>EC<sup>6,7</sup></b> Emergency Circuit Wiring	<b>EMR</b> Remote Micro Inverter (consult factory)	<b>EM<sup>6,7,8</sup></b> Integral EM Battery Pack (non-IC Rated)				
						* See page 8 for full details and restrictions * For EM with sensors, please consult factory * EM available in 4' and >6'. Please consult factory for 5'.	
Configuration Options	<b>L9<sup>9</sup></b> Unlit Horizontal 90° Corner	<b>T9<sup>9</sup></b> Lit "T" section	<b>X9<sup>9</sup></b> Lit "X" section				
						* See pages 11-12 for full details and restrictions	



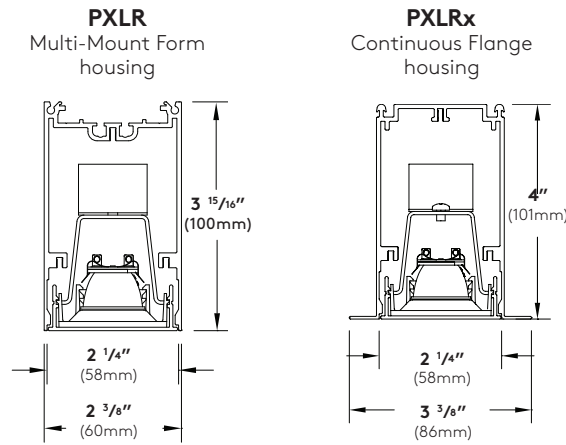

**Construction:**

**Housing** - Continuous, low copper 6063-T6 extruded aluminum profile with aluminum endcaps, available as Individual fixtures (up to 8') or Runs.

**Faceplate** - Extruded aluminum profile with laser cut cells for accuracy.

**Baffles** - Injection molded nylon material with a semi-matte Black or White finish.

**Reflectors** - Precision-designed, injection molded polycarbonate material for accurate distributions and powerful lighting effects. Four different distributions available - 10° Very Narrow (20° beam angle), 20° Narrow (40° beam angle), 35° Medium (70° beam angle), or 50° Wide (100° beam angle).

**Optional Optics - Optional Optics** - Clear Lens (CL), Diffuse Lens (DF), Lightly Diffuse Lens (LF), or Hexcell Louver (HX), snaps in behind the baffle. Optics cannot be combined within the same cell.

**Mounting(s)** - Spackle in (drywall), Slot Grid, Decoustic, T-Bar Grid, Perimeter, Rotating Crossbar, and Threaded Stud Mountings (see pages 3 through 6 for details).

**Standard Luminaire Lengths** - All standard luminaires are supplied in nominal lengths to ensure even distribution of optical cells. Runs and Configurations are available in approximately 2" increments (due to MRC size) starting at the nominal 8' fixture length.  
\*\*Individual luminaires are not joinable in the field.

**Exact Length Luminaries** - Individual luminaires, Runs, and Configurations are available to meet your project needs. Please consult factory with your requirements.

**PX Joiner** - Runs and Configurations are supplied in multiple housings that are joined together in the field using the supplied PX Joiner system. This allows ease of installation (see page 8 for details).

**Weight** - 2.5 lb. per foot

**Electrical/Performance:**

**LED Light Engine** - Brand-name mid-power LEDs create a high efficiency LED light engine with a reported lumen maintenance of 97.3% at 10,000 hours, 180 mA drive current and >55°C case temperature. Calculated L80 lumen maintenance of > 60,000 hours @ 25°C. Lumen maintenance values calculated in accordance to TM-21 procedures based on LM-80 compliant reported measurement data. For Title 24 compliant model numbers, please consult factory.

**Photometrics** - Consult website or factory for IES Files. Photometric lumen measurement complies with IES LM-79-08 testing procedures. Due to the LED manufacturer's tolerances, the listed output has a ±5% tolerance. For outputs based on different optics or CCT, please see pages 13-17 for details.

**CCT** - Available in 2700K, 3000K, 3500K, and 4000K, tolerance within a 3-step MacAdam ellipse.

**CRI** - 90+.

**All Drivers** - High efficient, constant current, soft start, Electronic Class 2 with a PFC>0.90. For more detailed information on the available drivers, please see page 7.

**Sensors** - Selux offers a variety of integral sensor options. For details and specifications, please see to page 9.

**Emergency** - There are Multiple Emergency Options Available, Emergency Circuit, Remote Micro Inverter and Integral EM Battery Pack. Integral EM available in limited 4' and all ≥8' lengths. Please consult factory for use of sensors with emergency option. See page 9 for details.

**Thermal Performance:**

**Ambient Operating Temperature** - Luminaires are suitable for maximum ambient temperature of 35°C (95°F) for all drivers.

Luminaires are suitable for minimum ambient temperatures of -40°C (-40°F) for DIM, DIL, DED, D01, and DL01 drivers; 0°C (32°F) for DC2 and DE1 drivers.

**Luminaire Finish:**

**Powder Coat** - All Selux luminaries are finished in high quality polyester powder coating in our Tiger Drylac certified facility and are tested in accordance with test specifications for coatings from ASTM and PCI.

All products undergo a five stage intensive pretreatment process where product is thoroughly cleaned, phosphated, and sealed. Selux powder coated products provide excellent salt and humidity resistance as well as ultra violet resistance for color retention.

Standard colors for Piix™ MRC are White (WH), Semi-Matte Black (BL), and Silver (SV). Selux premium colors (SP) are available, please specify from your Selux color selection guide.

**Warranty:**

**5 Year Limited LED Luminaire Warranty** - Selux offers a 5 Year Limited Warranty to the original purchaser that the Piix™ MRC luminaire shall be free from defects in material and workmanship for up to five (5) years from date of shipment. This limited warranty covers the LED driver and LED light engine when installed according to Selux instructions and operated within the Ambient Temperature. For additional details and exclusions, see "Selux Terms and Condition of Sale."

**Certifications and Compliance:**

NRTL - For dry locations (i.e. cULus, cCSAus)  
NRTL - For damp locations with the clear or diffuse secondary optics (i.e. cULus, cCSAus)  
ARRA Compliant  
ADA Compliant when mounted parallel to the wall  
RoHS Compliant  
IC Rated (EM option is non-IC Rated)

1/2" Spackle Flange Mounting (SF1)

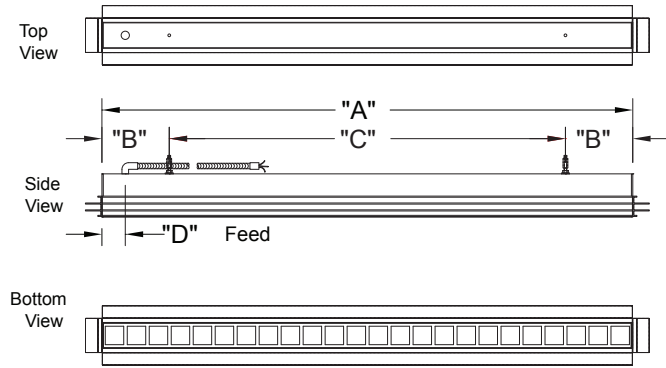

1/2" Spackle Flange Mounting (SF1)

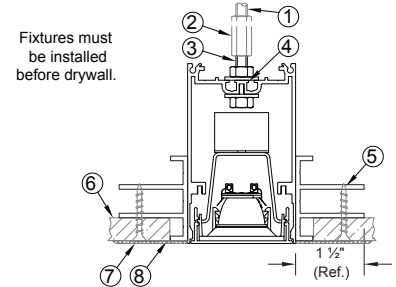

5/8" Spackle Flange Mounting (SF2)

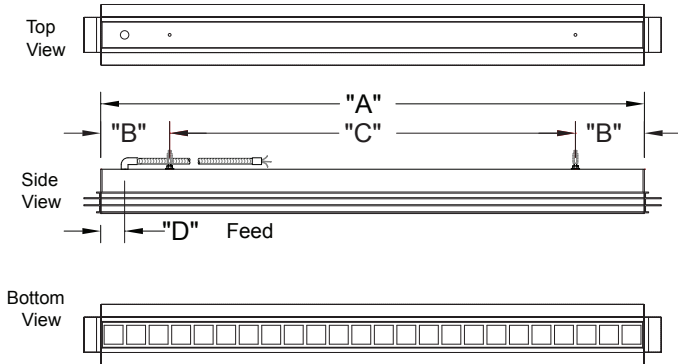

5/8" Spackle Flange Mounting (SF2)

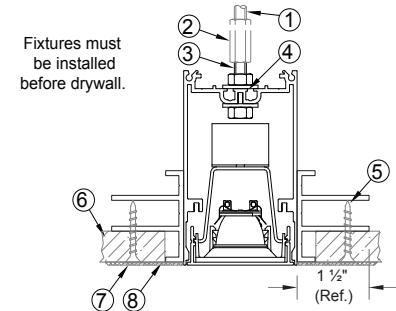

After Drywall Flange Mounting (SF3)

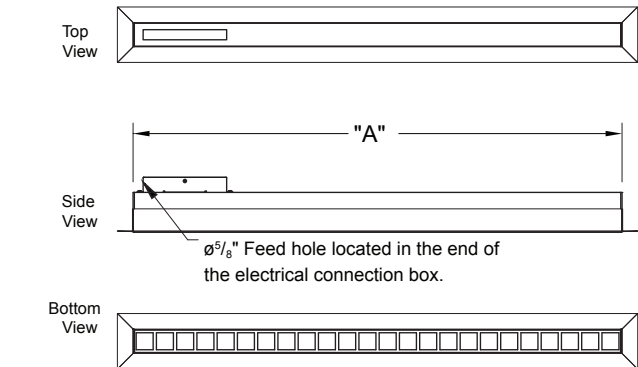

After Drywall Flange Mounting (SF3)

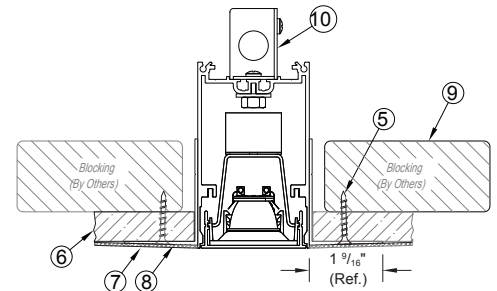

Spackle Flange Mounting (SF1, SF2 and SF3) - Dimensions								
Nominal Length	"A" Overall Length without Flange		"B" End Suspensions		* "C" (Reference) Mid Suspension		"D" Feed Location	
	Feet/Inch	MM	Feet/Inch	MM	Feet/Inch	MM	Feet/Inch	MM
02 (2 ft.)	2' - 5/16"	617	0' - 1 5/8"	41	1' - 1/16"	534	0' - 4 1/8"	105
03 (3 ft.)	3' - 5/16"	922	0' - 6 1/8"	156	2' - 1/16"	611	0' - 2 1/8"	54
04 (4 ft.)	4' - 5/16"	1227	0' - 6 1/8"	156	3' - 1/16"	915	0' - 2 1/8"	54
05 (5 ft.)	5' - 5/16"	1531	0' - 6 1/8"	156	4' - 1/16"	1220	0' - 2 1/8"	54
06 (6 ft.)	6' - 5/16"	1836	0' - 6 1/8"	156	5' - 1/16"	1525	0' - 2 1/8"	54
07 (7 ft.)	7' - 5/16"	2141	0' - 6 1/8"	156	6' - 1/16"	1830	0' - 2 1/8"	54
08 (8 ft.)	8' - 5/16"	2446	0' - 6 1/8"	156	7' - 1/16"	2135	0' - 2 1/8"	54

\*Dimension(s) rounded to the nearest 1/16" with a ± 1/16" (1mm) tolerance.

- 1/4"-20 Threaded rod to structure (supplied and installed by others).
- 1/4"-20 Coupler hardware (supplied and installed by others).
- 2" 1/4"-20 Stud (by Selux).
- 5/16" (Ø7mm) mounting hole.
- Drywall screw (Reference)
- Drywall (Reference)
- 1/2" Plaster skimcoat (Reference)
- Drywall tape (Reference)
- Blocking to secure fixture (by others)
- Electrical connection box, removable side cover for electrical connection pre-installation. Once installed, the wiring is accessible from below the ceiling through the luminaire.

### Slot Grid Mounting (SG)

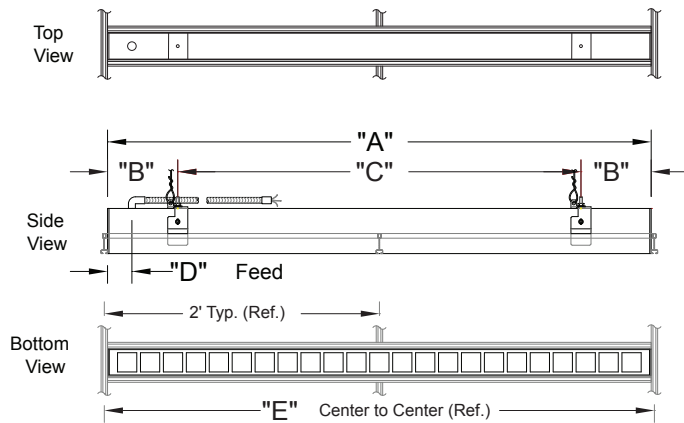

### 1/16" Slot Grid Mounting (SG) (Wire Suspension or 1/4"-20 Stud)

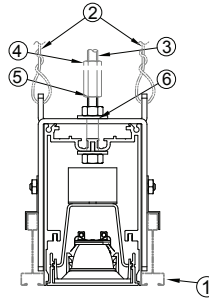

1. 1/16" Slot grid (shown as ref.)
2. Support wire to structure (supplied and installed by others).
3. 1/4"-20 Threaded rod to structure (supplied and installed by others).
4. 1/4"-20 Coupler hardware (supplied and installed by others).
5. 2" 1/4"-20 Stud (by Selux).
6. 7/16" (Ø7mm) mounting hole.

Slot Grid Mounting (SG) - Dimensions

Nominal Length	"A" Housing Length		**"B" End Suspensions		"C" Mid Suspension		"D" Feed Location		"E" Grid Spacing
	Feet/Inch	MM	Feet/Inch	MM	Feet/Inch	MM	Feet/Inch	MM	
02 (2 ft.)	1' - 11 7/16"	595	0' - 1 5/8"	41	1' - 8 3/16"	513	0' - 4 1/8"	105	2' Center to Center
04 (4 ft.)	3' - 11 7/16"	1205	0' - 6 1/8"	156	2' - 11 3/16"	894	0' - 2 1/8"	54	4' Center to Center
05 (5 ft.)	4' - 11 7/16"	1510	0' - 6 1/8"	156	3' - 11 3/16"	1199	0' - 2 1/8"	54	5' Center to Center
06 (6 ft.)	5' - 11 7/16"	1815	0' - 6 1/8"	156	4' - 11 3/16"	1503	0' - 2 1/8"	54	6' Center to Center
08 (8 ft.)	7' - 11 7/16"	2424	0' - 6 1/8"	156	6' - 11 3/16"	2113	0' - 2 1/8"	54	8' Center to Center

\*Dimension(s) rounded to the nearest 1/16" with a ± 1/16" (1mm) tolerance.

### Decoustic Mounting (DC)

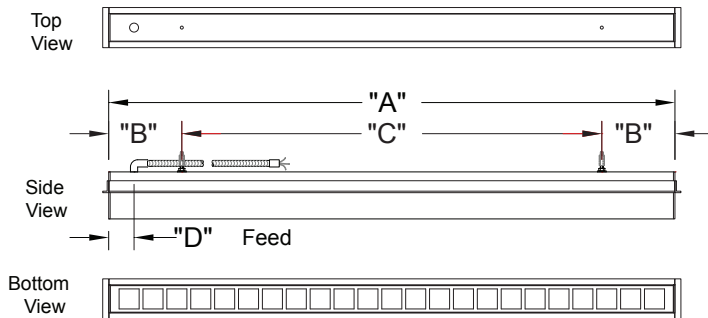

### Decoustic Mounting (DC) (Panels up to 2" thick)

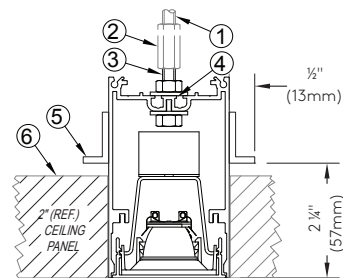

Decoustic Mounting (DC) - Dimensions

Nominal Length	"A" Housing Length		**"B" (Ref.) End Suspensions		"C" Mid. Suspension		"D" Feed Location	
	Feet/Inch	MM	Feet/Inch	MM	Feet/Inch	MM	Feet/Inch	MM
02 (2 ft.)	2' - 0 5/16"	617	0' - 1 5/8"	41	1' - 9 1/16"	534	0' - 4 1/8"	105
03 (3 ft.)	3' - 0 5/16"	922	0' - 6 1/8"	156	2' - 0 1/16"	611	0' - 2 1/8"	54
04 (4 ft.)	4' - 0 5/16"	1227	0' - 6 1/8"	156	3' - 0 1/16"	915	0' - 2 1/8"	54
05 (5 ft.)	5' - 0 5/16"	1531	0' - 6 1/8"	156	4' - 0 1/16"	1220	0' - 2 1/8"	54
06 (6 ft.)	6' - 0 5/16"	1836	0' - 6 1/8"	156	5' - 0 1/16"	1525	0' - 2 1/8"	54
07 (7 ft.)	7' - 0 5/16"	2141	0' - 6 1/8"	156	6' - 0 1/16"	1830	0' - 2 1/8"	54
08 (8 ft.)	8' - 0 5/16"	2424	0' - 6 1/8"	156	7' - 0 1/16"	2135	0' - 2 1/8"	54

\*Dimension(s) rounded to the nearest 1/16" with a ± 1/16" (1mm) tolerance.

1. 1/4"-20 Threaded rod to structure (supplied and installed by others).
2. 1/4"-20 Coupler hardware (supplied and installed by others).
3. 2" 1/4"-20 Stud (by Selux).
4. 7/16" (Ø7mm) mounting hole.
5. 1/2" wide aluminum angle runs the entire length of fixture to block view into plenum area from below fixture.
6. Suitable for Decoustic® ceiling panel installations with panels up to 2" thick (supplied and installed by others). Other ceiling systems possible, please consult factory. Decoustic® is a registered trademark of Decoustics Ltd. Corporation.

### T-Bar Mounting (TB)

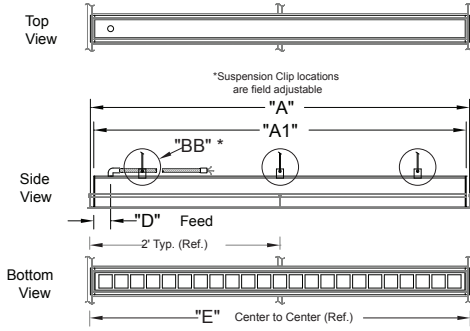

### T-Bar with Stud Mounting (TBS)

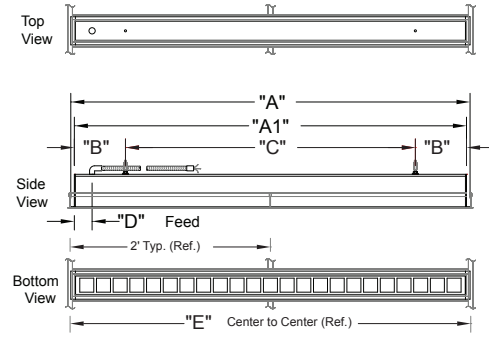

### T-Bar with Suspension Clips (TB)

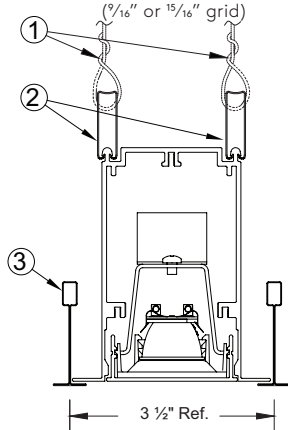

### T-Bar with 1/4" -20 Stud (TBS)

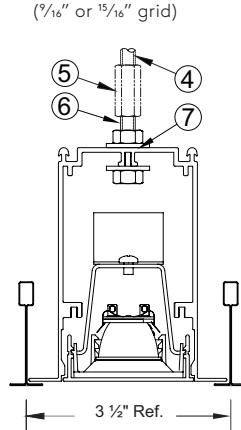

1. Support wire to structure (supplied and installed by others).
2. Spring steel suspension clips located approximately every 4 feet. (supplied by Selux).
3. 1/8" T-bar grid (shown as ref.)
4. 1/4"-20 Threaded rod to structure (supplied and installed by others).
5. 1/4"-20 Coupler hardware (supplied and installed by others).
6. 2" 1/4"-20 Stud (by Selux).
7. 0.5/16" (Ø7mm) mounting hole.

T-Bar (TB and TBS) and Perimeter Mount (PMT) - Dimensions

Nominal Length	"A" O.A.L. with Flange		"A1" O.A.L. without Flange		"B" End Suspensions		"BB" (TB mtg.) Suspension Clips	** "C" (Ref.) Mid. Suspension		"D" Feed Location		"E" Grid Spacing	"F" Wall Angle	
	Feet/Inch	MM	Feet/Inch	MM	Feet/Inch	MM	Quantity	Feet/Inch	MM	Feet/Inch	MM		Feet/Inch	MM
*02 (2 ft.)	1' - 11 13/16"	605	1' - 11"	584	0' - 4 1/2"	114	4x	1' - 2"	355	0' - 1 1/8"	29	2' Center to Center	1' - 11 13/16"	605
*04 (4 ft.)	3' - 11 13/16"	1215	3' - 11"	1193	0' - 6 1/8"	156	6x	2' - 10 3/4"	882	0' - 2 1/8"	54	4' Center to Center	3' - 11 13/16"	1215
*05 (5 ft.)	4' - 11 13/16"	1520	4' - 11"	1498	0' - 6 1/8"	156	6x	3' - 10 3/4"	1187	0' - 2 1/8"	54	5' Center to Center	4' - 11 13/16"	1520
*06 (6 ft.)	5' - 11 13/16"	1825	5' - 11"	1803	0' - 6 1/8"	156	6x	4' - 10 3/4"	1492	0' - 2 1/8"	54	6' Center to Center	5' - 11 13/16"	1825
*08 (8 ft.)	7' - 11 13/16"	2434	7' - 11"	2412	0' - 6 1/8"	156	8x	6' - 10 3/4"	2101	0' - 2 1/8"	54	8' Center to Center	7' - 11 13/16"	2434

\*For other lengths consult factory

\*\*Dimension(s) rounded to the nearest 1/16" with a ± 1/16" (1mm) tolerance.

### Perimeter Mounting T-Bar Length (PMT)

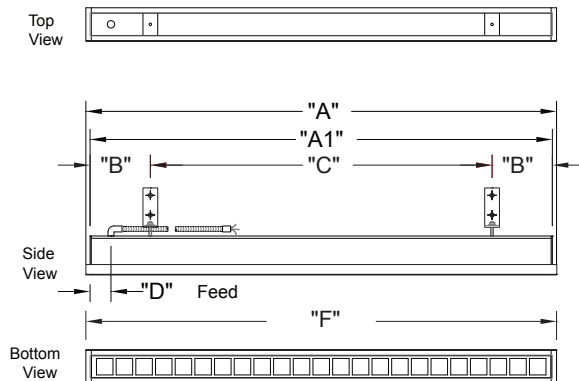

### Perimeter Mount T-Bar Length (PMT)

(Recessed Wall Mounting)

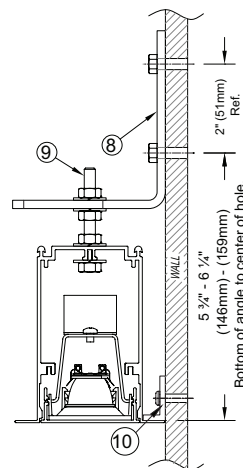

8. Steel Wall Bracket with provision for 1/4"-20 fasteners (hardware to code by others).
9. 2" 1/4"-20 Stud (by Selux).
10. 1/2" x 1" aluminum wall angle allows a gap between flange and wall to create shadow line allowing for unevenness of wall. Provision for #10 screws supplied approximately every 2 feet (hardware to code by others).

### Rotating Crossbar Mounting (RC)

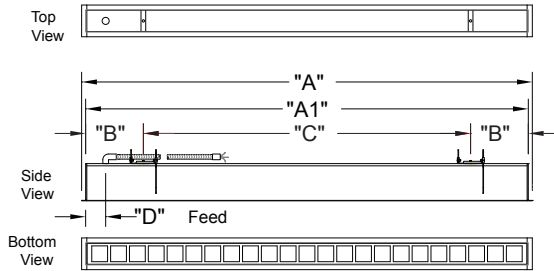

Rotating Crossbars (RC)  
(1/4" to 2" thick ceiling)

### 1/4"-20 Threaded Stud Mounting (TS)

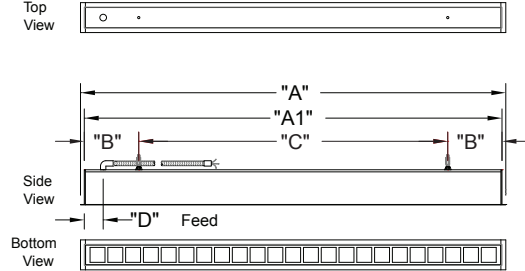

1/4"-20 Threaded Stud (TS)  
(1" Threaded Stud)

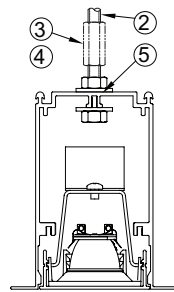
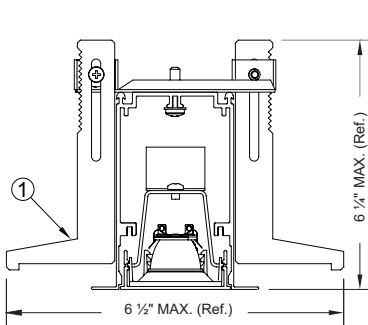

1. Rotating crossbar intended for inaccessible ceilings, adjustable for ceiling thickness of 1/4" to 2".
2. 1/4"-20 Threaded rod to structure (supplied and installed by others).
3. 1/4"-20 Coupler hardware (supplied and installed by others).
4. 2" 1/4"-20 Stud (by Selux).
5. 5/16" (Ø7mm) mounting hole.

Rotating Crossbar (RC), Threaded Stud (TS), and Perimeter Mountings (PM) - Dimensions

Nominal Length	"A" Overall Length with Flange		"A1" Overall Length without Flange		"B" End Suspensions		** "C" (Ref.) Mid. Suspension		"D" Feed Location		"E" Wall Angle	
	Feet/Inch	MM	Feet/Inch	MM	Feet/Inch	MM	Feet/Inch	MM	Feet/Inch	MM	Feet/Inch	MM
02 (2 ft.)	2' - 1 1/8"	639	2' - 0 5/16"	617	0' - 4 1/2"	114	1' - 3 5/16"	388	0' - 1 1/8"	29	2' - 1 1/8"	639
03 (3 ft.)	3' - 1 1/8"	943	3' - 0 5/16"	922	0' - 6 1/8"	156	2' - 0 1/16"	611	0' - 2 1/8"	54	3' - 1 1/8"	943
04 (4 ft.)	4' - 1 1/8"	1248	4' - 0 5/16"	1227	0' - 6 1/8"	156	3' - 0 1/16"	915	0' - 2 1/8"	54	4' - 1 1/8"	1248
05 (5 ft.)	5' - 1 1/8"	1553	5' - 0 5/16"	1531	0' - 6 1/8"	156	4' - 0 1/16"	1220	0' - 2 1/8"	54	5' - 1 1/8"	1553
06 (6 ft.)	6' - 1 1/8"	1858	6' - 0 5/16"	1836	0' - 6 1/8"	156	5' - 0 1/16"	1525	0' - 2 1/8"	54	6' - 1 1/8"	1858
07 (7 ft.)	7' - 1 1/8"	2163	7' - 0 5/16"	2141	0' - 6 1/8"	156	6' - 0 1/16"	1830	0' - 2 1/8"	54	7' - 1 1/8"	2163
08 (8 ft.)	8' - 1 1/8"	2434	8' - 0 5/16"	2446	0' - 6 1/8"	156	7' - 0 1/16"	2135	0' - 2 1/8"	54	8' - 1 1/8"	2467

\*RC mounting, consult factory for lengths under 2'

\*\*Dimension(s) rounded to the nearest 1/16" with a ± 1/16" (1mm) tolerance.

### Perimeter Mounting (PM)

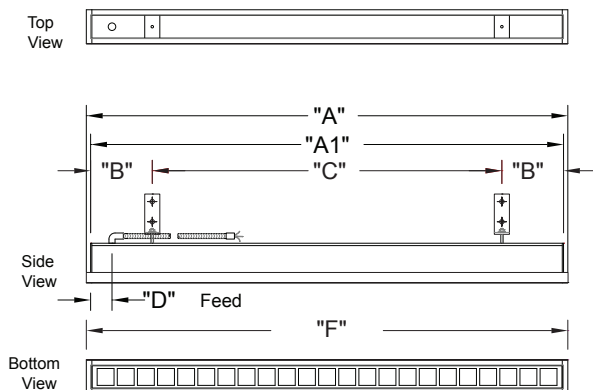

### Perimeter Mount (PM) (Recessed Wall Mounting)

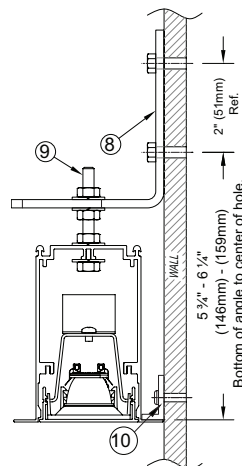

8. Steel Wall Bracket with provision for 1/4"-20 fasteners (hardware to code by others).
9. 2" 1/4"-20 Stud (by Selux).
10. 1/2" x 1" aluminum wall angle allows a gap between flange and wall to create shadow line allowing for unevenness of wall. Provision for #10 screws supplied approximately every 2 feet (hardware to code by others).

**Drivers:**

**0-10V linear dimming (DIM)**

Luminaires supplied with drivers offering the capability of either normal switched operation or 0-10V dimming for linear dimming curve. Fixtures ship wired for dimming. For on/off functionality, simply cap the dimming leads. Minimum dimming level preset at factory to 1%.

**0-10V logarithmic eldoLED ECOdrive (DIL)**

Luminaires supplied with drivers offering the capability of either normal switched operation or 0-10V dimming for logarithmic dimming curve. Fixtures ship wired for dimming. For on/off functionality, simply cap the dimming leads. Minimum dimming level preset at factory to 1%.

**eldoLED SOLOdrive 0-10V linear dimming (D01)**

Luminaires supplied with SOLOdrive 0-10V dimming driver for linear dimming curve. Minimum dimming level preset at factory to 0.1% and “dim to dark”.

**eldoLED SOLOdrive 0-10V logarithmic dimming (DL01)**

Luminaires supplied with SOLOdrive 0-10V dimming driver for logarithmic dimming curve. Minimum dimming level preset at factory to 0.1% and “dim to dark”.

**eldoLED ECOdrive DALI-2 dimming (DED)**

Luminaires supplied with ECOdrive DALI-2 dimming driver for logarithmic dimming curve. Minimum dimming level preset at factory to 1%. For “dim to dark” (down to 0.1%), please consult factory.

**LUTRON EcoSystem dimming (DE1)**

Luminaires supplied with Hi-Lume EcoSystem (4 wire, digital link) dimming driver programmed for Constant Current Reduction (CCR). Minimum dimming level down to 1% with SoftOn/FadeToBlack.

\* For control recommendations, please contact driver manufacturer

* Driver Quantity													
Fixture Length													
Dimming Protocol	1 ft.	2 ft.	3 ft.	4 ft.	5 ft.	6 ft.	7 ft.	8 ft.	9 ft.	10 ft.	11 ft.	12 ft.	RUN
DIM, DIL, DE1	1	1	2	1	2	2	2	2	3	3	4	3	Approximately 1 driver per 4 ft.
DED, D01, DL01	1	1	1	1	2	2	2	2	3	3	3	3	Approximately 1 driver per 4 ft.

\*For inrush and control current, please refer to the driver manufacturers’ spec sheets.

Wiring Diagrams

- 0-10V linear (DIM)
- 0-10V logarithmic eldoLED ECOdrive (DIL)
- DALI logarithmic eldoLED ECOdrive (DED)
- 0-10V linear eldoLED SOLOdrive (D01)
- 0-10V logarithmic eldoLED SOLOdrive (DL01)

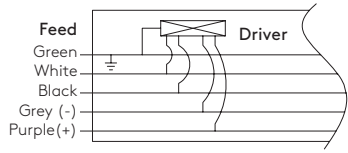

Standard Wiring supplied for all drivers	Green = Ground White = Neutral Black = Hot
<b>- The following wire(s) are in addition to the standard above -</b>	
DIM, DIL, DED, D01, DL01	Gray = (-) DALI or 0-10V Dimming Control Purple = (+) DALI or 0-10V Dimming Control
DC2	No additional wires
DE1	Violet = "E1" Digital Link Dimming Control Violet/White = "E2" Digital Link Dimming Control

Lutron 2-Wire (DC2)

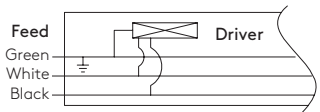

Lutron EcoSystem (DE1)

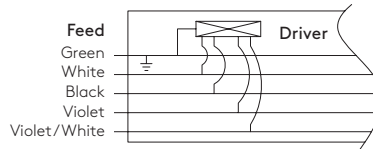

Sensor Wiring Diagrams

Enlighted

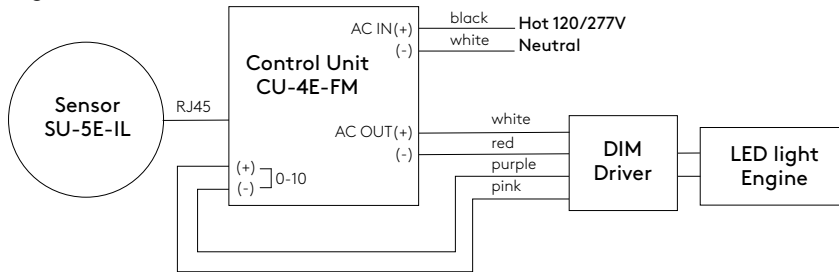

Sensor Switch

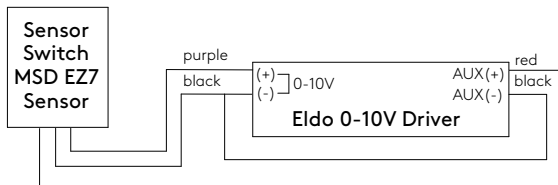

Lutron Vive

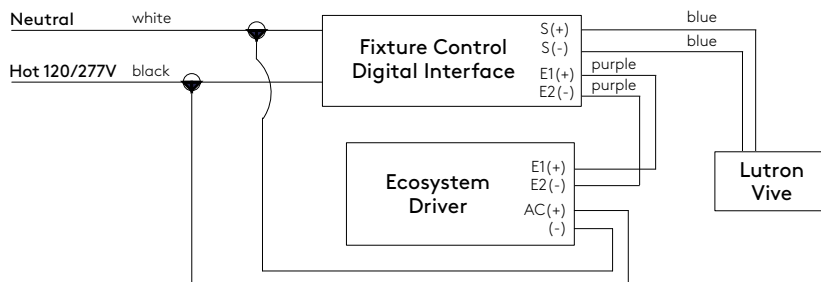

**Fuse (FS)** - Fusing, luminaires supplied with an in-line fuse located on the hot wire for each feed. (supplied with an 8A slow burn fuse).

**Separate Switching (SS)** - Luminaires available with separately switched 4' (nominal) sections starting at 7' and up. Luminaire is intended to be wired to the same panel/breaker (not intended for Emergency use).

\* To specify this option, the number of separately switched sections and locations of these sections must be provided at time of order.

\* If the project requires different separate switching than outlined above please consult the factory.

\* For Separate Switching with sensors, please consult factory.

**Emergency Wiring (EC)** - EC luminaires are intended to be wired to separate panels/breakers for emergency use. See install instructions for proper wiring.

For 1' to 6' nominal luminaires, the entire fixture is wired for operation on emergency circuit.

For 7' and up nominal luminaires, the first 4' nominal length is wired for operation by a separate EM circuit by default to meet the required "Life Safety Code" (NFPA 101).

If a different configuration is needed, please consult factory.

Note: Wiring may vary slightly due to on-site conditions or local codes. Please follow all safety installation protocols contained within install instructions when installing luminaire.

**Emergency Battery (EM)** - The EM battery is located integral to fixture and is factory pre-wired. See install instructions for proper wiring.

10W constant power Emergency Battery Pack.

Direct fixtures are available for Emergency battery use in 4' and ≥6. Due to size constraints, EM is not available in 5' fixtures.

For individual fixtures, emergency option will illuminate the first 4' section of fixture. For continuous runs, please consult factory to advise on 4' section intended for emergency use.

For fixtures >8' or if a different configuration is needed, please consult factory.

Emergency test switch is located next to the geartray, behind the lens.

Emergency battery option is UNV for use with 120V or 277V and is not available for 347V.

\* Please note battery pack requires an unswitched hot.

\* For EM with sensors, please consult factory.

\* If a different configuration is needed, please consult factory.

Note: Wiring may vary slightly due to on site conditions or local codes. Please follow all safety installation protocols contained within install instructions when installing luminaire.

## Joiner System - standard for Runs and Configurations

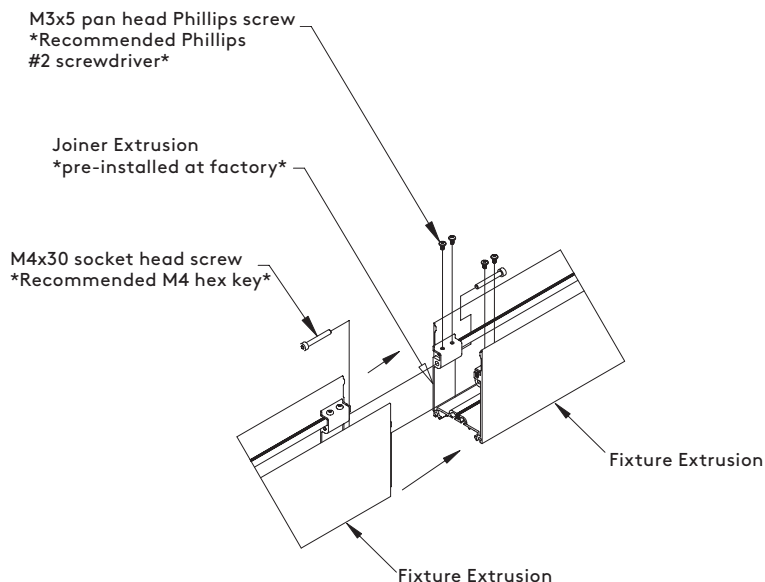

Sensor Ordering Chart		
Quantity	Sensor	Settings*
x Number of Sensors	<b>S</b> Sensor Switch MSD EZ <b>V</b> Lutron Vive DFCSJ	<b>1</b> Daylight <b>2</b> Occupancy/Vacancy <b>3</b> Daylight/Occupancy/Vacancy

**Sensor Switch MSD EZ (S)**

Occupancy/vacancy and daylight harvesting. For full functionality and programming options, select settings option 3. If a different settings option is selected, other settings may be unavailable. For full details, please see MSD EZ spec sheets on the Sensor Switch website. Must be paired with DIM driver selection. Manual control of dimming not available with MSD EZ sensor.

\*Sensor can control up to 30 drivers. Please refer to driver quantity chart on page 7. Multiple sensors may be required for longer lengths.

**Lutron Vive DFCSJ (V)**

The DFCSJ-OEM-OCC provides the capabilities of daylight harvesting and occupancy/vacancy sensing. When integrated with the DFC-OEM-DBI (Fixture Control Digital Link Interface), the sensor is wirelessly compatible with the DE1 Lutron EcoSystem driver. Commissioning by certified Lutron technician.

\*Vive DFCSJ sensor can control up to a maximum of five (5) drivers per sensor. Please refer to driver chart on page 7. Multiple sensors may be required for longer lengths.

	Occupancy	Vacancy	Daylight Harvesting	Driver Compatibility
Sensor Switch MSD EZ (S)	✓	✓	✓	DIM
Lutron Vive DFCSJ (V)	✓	✓	✓	DE1

Please contact controls manufacturer for details prior to specifying.

**Factory Presets** - Sensors come from the sensor manufacturer with factory presets for each of the settings in above chart. Please see sensor manufacturers' spec sheets for details on presets and re-programming.

**Commissioning** - Commissioning of sensors and installation by others. Contact sensor manufacturer for details and costs associated with commissioning the system prior to specification of sensors.

**Standard Sensor Placement** - for other placement options, please consult factory. For functionality and limitations, please see sensor details above.

Qty 1 Sensor - Beginning



Qty 2 Sensor - Beginning and End (9' fixtures and longer)



Qty 3+ Sensor - For spacing between sensors, please consult the sensor manufacturer.

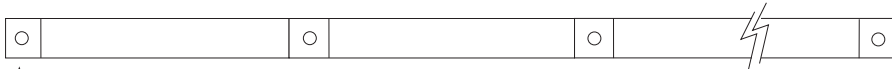

↑  
Beginning of Run

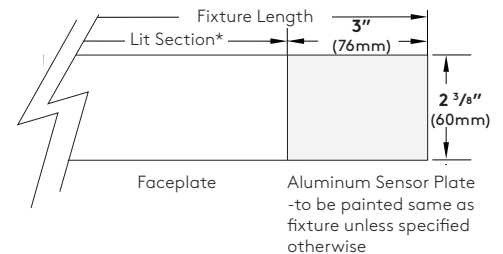

\*Lit section will be the fixture length minus 3" for sensor plate.

- Notes: 1. For spacing between sensors, please consult the sensor manufacturer.
- 2. Exact sensor placement and coverage will be defined by approved factory drawing.
- 3. Sections controlled by sensors may not be symmetrical - consult factory for layout.

**Standard Recessed (PXL) shapes/configurations:**

Listed below are the minimum lengths and details for standard shapes. These standard shapes can be combined with each other and/or the standard luminaire lengths, ensuring full even illumination. If you have any questions, please consult the factory.

The minimum standard lengths for "L" shapes:

- L9 open shapes is 2' x 2' nominal (example: leg, 90, leg)
- L9 closed shapes is 4' x 4' nominal (example: 90, leg, 90)
- L9 corners can be joined directly together to provide a 4' x 4' nominal shape

\*L9 corners are not lit.

\*For sensors in configurations, please consult factory.

The minimum standard lengths for "T" and "X" shapes:

- T9 = 2' nominal on the short leg and 4' nominal on the long side
- X9 = 4' nominal for either direction
- \* T9 and X9 corners are lit with an MRC in the corner.

**Project Specific Recessed (PXL) shapes/configurations:**

Selux is capable of supplying a wide range of project solutions including different shapes, angles, and sizes to meet the project requirements. Due to the complex nature of these project specific layout(s) we ask that you please consult the factory with the project requirements for review.

L9 - Horizontal Center

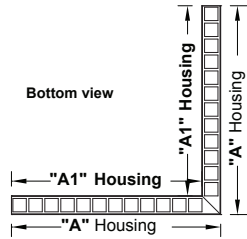

T9 - "T" Section

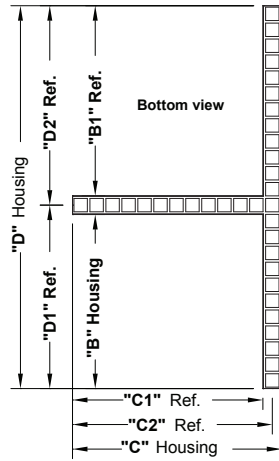

X9 - "X" Section

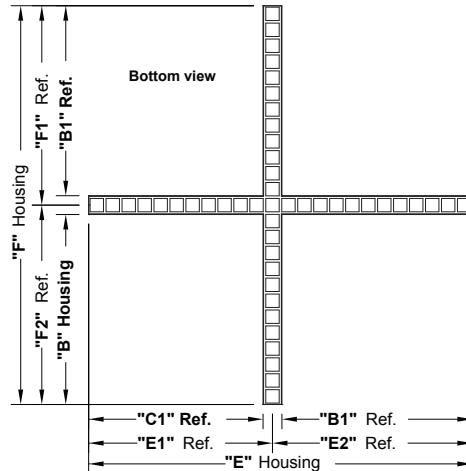

Recessed (PXL) Corner and Section - Dimensions

Nominal Length	L9		T9		X9	
	Feet/Inch	MM	Feet/Inch	MM	Feet/Inch	MM
"A" Housing	2' - 2 1/16"	678	N/A	N/A	N/A	N/A
"A1" Housing	2' - 2 3/16"	666	N/A	N/A	N/A	N/A
"B" Housing	1' - 11 5/16"	593	1' - 9 13/16"	555	1' - 11 13/16"	606
* "B1" Ref.	1' - 11 13/16"	606	1' - 11 13/16"	606	1' - 11 13/16"	606
"C" Housing	N/A	N/A	2' - 2 13/16"	666	N/A	N/A
* "C1" Ref.	N/A	N/A	2' - 2 11/16"	678	1' - 9 13/16"	555
* "C2" Ref.	N/A	N/A	1' - 11 13/16"	606	N/A	N/A
* "C3" Ref.	N/A	N/A	2' - 1"	636	N/A	N/A
"D" Housing	N/A	N/A	4' - 1/16"	1220	N/A	N/A
* "D1" Ref.	N/A	N/A	1' - 11"	585	N/A	N/A
* "D2" Ref.	N/A	N/A	2' - 1"	636	N/A	N/A
"E" Housing	N/A	N/A	N/A	N/A	4' - 1/16"	1220
* "E1" Ref.	N/A	N/A	N/A	N/A	1' - 11"	585
* "E2" Ref.	N/A	N/A	N/A	N/A	2' - 1"	636
"F" Housing	N/A	N/A	N/A	N/A	4' - 2 1/16"	1271
* "F1" Ref.	N/A	N/A	N/A	N/A	2' - 1"	636
* "F2" Ref.	N/A	N/A	N/A	N/A	2' - 1"	636

\*Dimension(s) rounded to the nearest 1/16" with a ± 1/16" (1mm) tolerance.

PXL

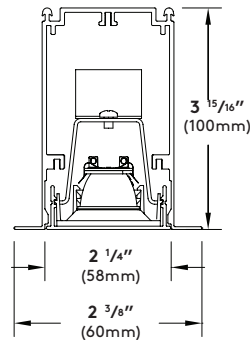

**Standard Recessed (PXL R1/R2) shapes/configurations:**

Listed below are the minimum lengths and details for standard shapes. These standard shapes can be combined with each other and/or the standard luminaire lengths, ensuring full even illumination. If you have any questions please consult the factory.

The minimum standard lengths for "L" shapes:

- L9 open shapes is 2' x 2' nominal (example, leg, 90, leg)
- L9 closed shapes is 4' x 4' nominal (example, 90, leg, 90)
- L9 can be joined directly to provide a 4' x 4' nominal shape

The minimum standard lengths for "T" and "X" shapes:

- T9 = 4' nominal on the short leg and 4' nominal on the long side
- X9 = 4' nominal for either direction

\*For sensors in configurations, please consult factory.

**Project Specific Recessed (PXL R1/R2) shapes/configurations:**

Selux is capable of supplying a wide range of project solutions including different shapes, angles, and sizes to meet the project requirements. Due to the complex nature of these project specific layout(s) we ask that you please consult the factory with the project requirements for review.

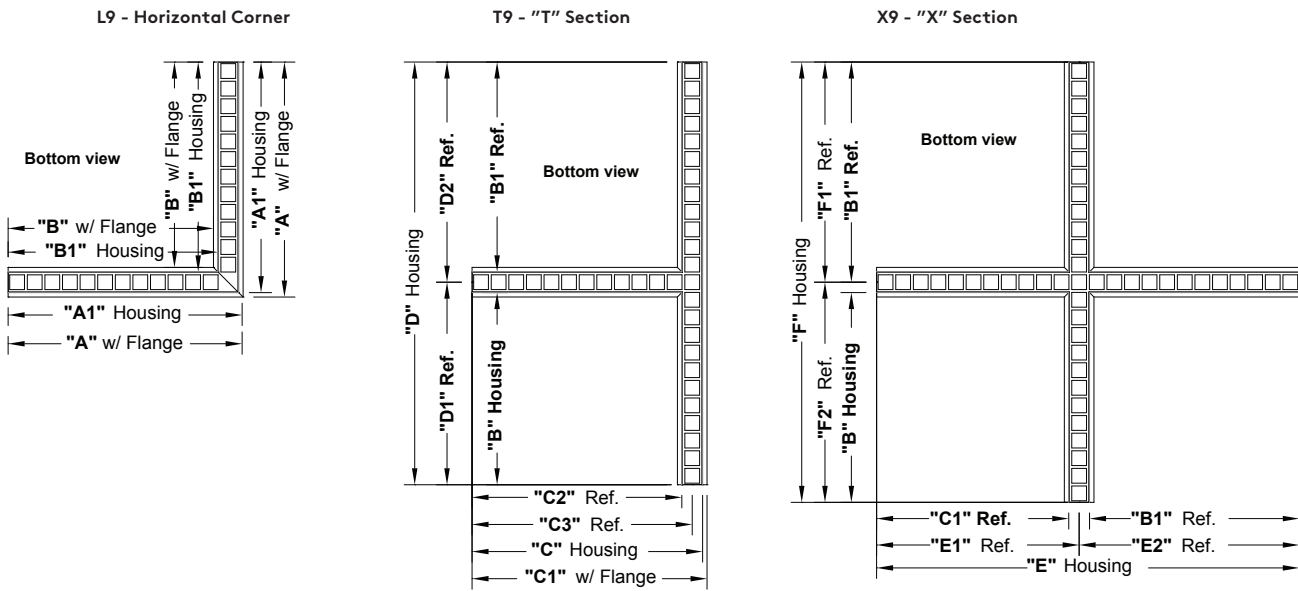

Recessed (PXL R1/R2) Flanged Corner and Section - Dimensions						
Nominal Length	L9		T9		X9	
	Feet/Inch	MM	Feet/Inch	MM	Feet/Inch	MM
"A" Housing	2' - 2 1/16"	678	N/A	N/A	N/A	N/A
"A1" Housing	2' - 2 3/16"	666	N/A	N/A	N/A	N/A
"B" Housing	1' - 11 13/16"	593	1' - 9 13/16"	555	1' - 11 13/16"	606
* "B1" Ref.	1' - 11 13/16"	606	1' - 11 13/16"	606	1' - 11 13/16"	606
"C" Housing	N/A	N/A	2' - 2 3/16"	666	N/A	N/A
* "C1" Ref.	N/A	N/A	2' - 2 11/16"	678	1' - 9 13/16"	555
* "C2" Ref.	N/A	N/A	1' - 11 13/16"	606	N/A	N/A
* "C3" Ref.	N/A	N/A	2' - 1"	636	N/A	N/A
"D" Housing	N/A	N/A	4' - 1/16"	1220	N/A	N/A
* "D1" Ref.	N/A	N/A	1' - 11"	585	N/A	N/A
* "D2" Ref.	N/A	N/A	2' - 1"	636	N/A	N/A
"E" Housing	N/A	N/A	N/A	N/A	4' - 0 1/16"	1220
* "E1" Ref.	N/A	N/A	N/A	N/A	1' - 11"	585
* "E2" Ref.	N/A	N/A	N/A	N/A	2' - 1"	636
"F" Housing	N/A	N/A	N/A	N/A	4' - 2 1/16"	1271
* "F1" Ref.	N/A	N/A	N/A	N/A	2' - 1"	636
* "F2" Ref.	N/A	N/A	N/A	N/A	2' - 1"	636

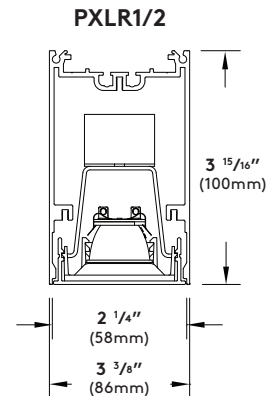

\*Dimension(s) rounded to the nearest 1/16" with a ± 1/16" (1mm) tolerance.

**Photometry**

20° Optics / Clear Lens / 44W / 3500K

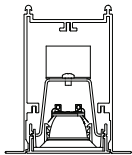

Catalog #: PXL-1B45-935-20-CL-X-04-XX-UNV  
Report #: 12546460.01  
Delivered Lumens: 2946  
Input Watts: 43.6  
Efficacy: 67 lm/W  
CCT: 4000K  
CRI: 93.7

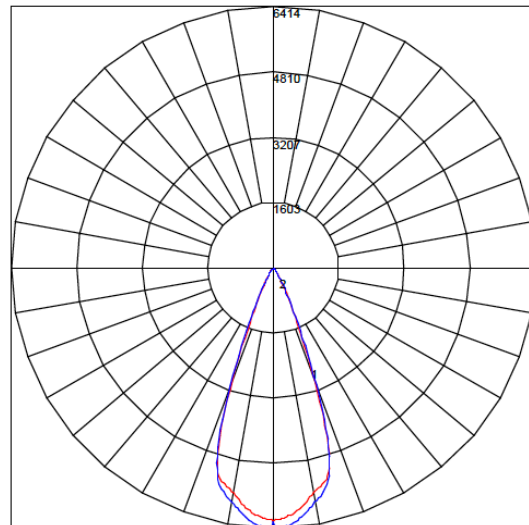

Maximum Candela = 6413.825 Located At Horizontal Angle = 0, Vertical Angle = .5  
# 1 - Vertical Plane Through Horizontal Angles (90 - 270)  
# 2 - Vertical Plane Through Horizontal Angles (0 - 180)

35° Optics / Clear Lens / 44W / 3500K

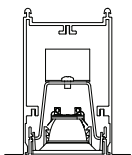

Catalog #: PXL-1B45-935-35-CL-X-04-XX-UNV  
Report #: 12546460.09  
Delivered Lumens: 3361  
Input Watts: 43.6  
Efficacy: 77 lm/W  
CCT: 4000K  
CRI: 93.7

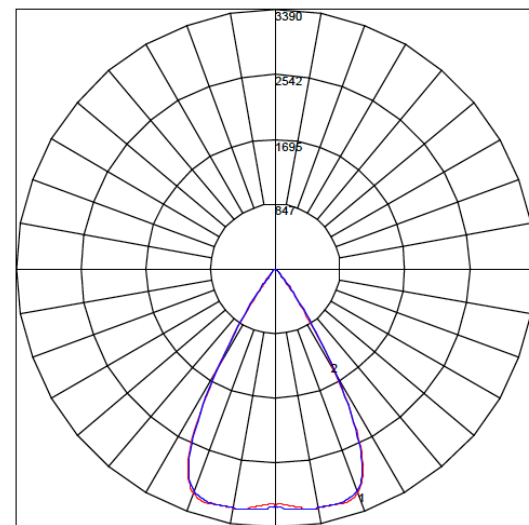

Maximum Candela = 3389.969 Located At Horizontal Angle = 45, Vertical Angle = 23.5  
# 1 - Vertical Plane Through Horizontal Angles (90 - 270)  
# 2 - Vertical Plane Through Horizontal Angles (0 - 180)

50° Optics / Clear Lens / 44W / 3500K

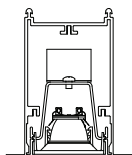

Catalog #: PXL-1B45-935-50-CL-X-04-XX-UNV  
Report #: 12546460.05  
Delivered Lumens: 3507  
Input Watts: 43.6  
Efficacy: 80 lm/W  
CCT: 4000K  
CRI: 93.7

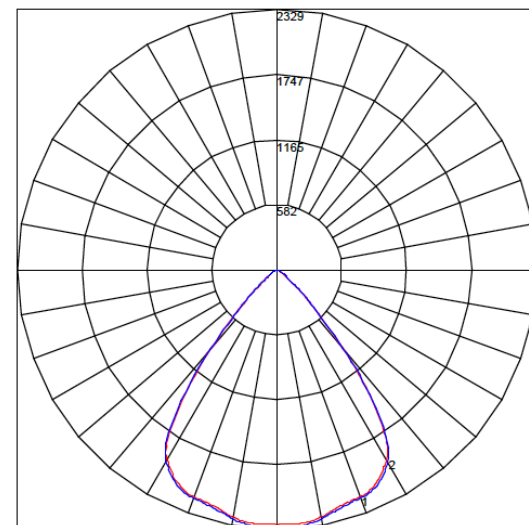

Maximum Candela = 2329.063 Located At Horizontal Angle = 0, Vertical Angle = .5  
# 1 - Vertical Plane Through Horizontal Angles (90 - 270)  
# 2 - Vertical Plane Through Horizontal Angles (0 - 180)

Photometry

20° Optics / Hexcell Louver / 44W / 3500K

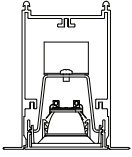

Catalog #: PXL-1B45-935-20-HX-X-04-XX-UNV  
Report #: 12546460.07  
Delivered Lumens: 1386  
Input Watts: 43.6  
Efficacy: 32 lm/W  
CCT: 4000K  
CRI: 93.7

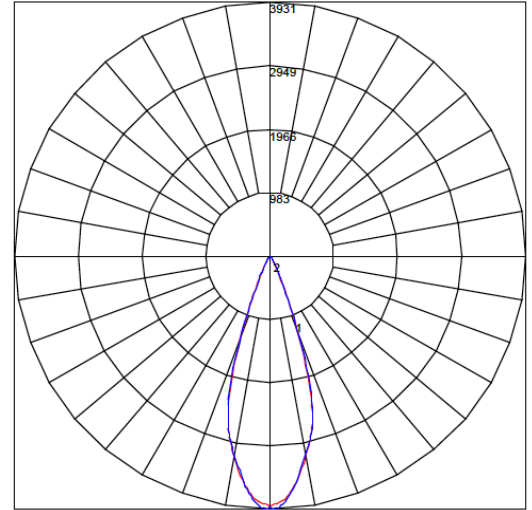

Maximum Candela = 3931.378 Located At Horizontal Angle = 0, Vertical Angle = .5  
# 1 - Vertical Plane Through Horizontal Angles (90 - 270)  
# 2 - Vertical Plane Through Horizontal Angles (0 - 180)

35° Optics / Hexcell Louver / 44W / 3500K

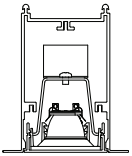

Catalog #: PXL-1B45-935-35-HX-X-04-XX-UNV  
Report #: 12546460.06  
Delivered Lumens: 1219  
Input Watts: 43.6  
Efficacy: 28 lm/W  
CCT: 4000K  
CRI: 93.7

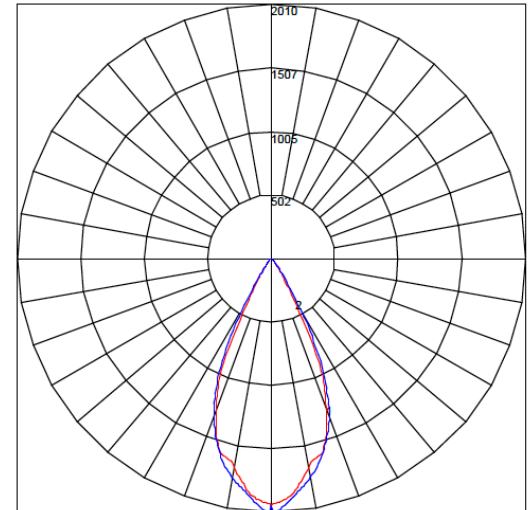

Maximum Candela = 2009.513 Located At Horizontal Angle = 0, Vertical Angle = .5  
# 1 - Vertical Plane Through Horizontal Angles (90 - 270)  
# 2 - Vertical Plane Through Horizontal Angles (0 - 180)

50° Optics / Hexcell Louver / 44W / 3500K

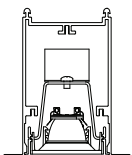

Catalog #: PXL-1B45-935-50-HX-X-04-XX-UNV  
Report #: 12546460.03  
Delivered Lumens: 1005  
Input Watts: 43.6  
Efficacy: 23 lm/W  
CCT: 4000K  
CRI: 93.7

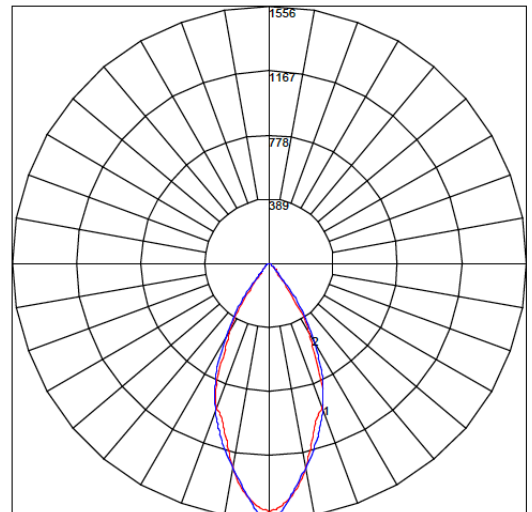

Maximum Candela = 1555.752 Located At Horizontal Angle = 0, Vertical Angle = .5  
# 1 - Vertical Plane Through Horizontal Angles (90 - 270)  
# 2 - Vertical Plane Through Horizontal Angles (0 - 180)

**Photometry**

20° Optics / 30% Diffuse Lens / 44W / 3500K

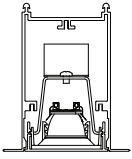

Catalog #: PXL-1B45-935-20-DF-X-04-XX-UNV  
Report #: 12546460.04  
Delivered Lumens: 2495  
Input Watts: 43.6  
Efficacy: 57lm/W  
CCT: 4000K  
CRI: 93.7

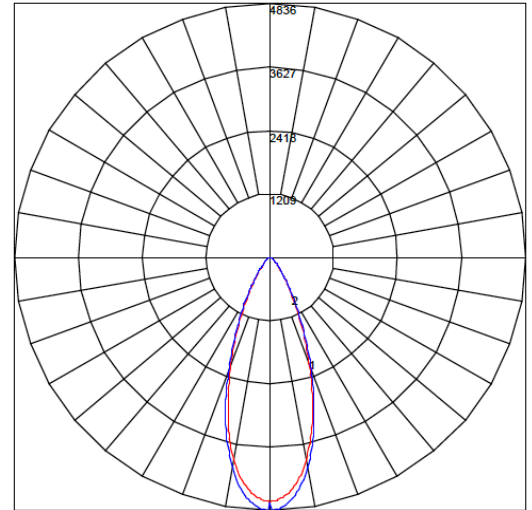

Maximum Candela = 4836.161 Located At Horizontal Angle = 0, Vertical Angle = .5  
# 1 - Vertical Plane Through Horizontal Angles (90 - 270)  
# 2 - Vertical Plane Through Horizontal Angles (0 - 180)

35° Optics / 30% Diffuse Lens / 44W / 3500K

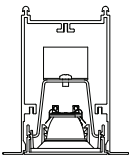

Catalog #: PXL-1B45-935-35-DF-X-04-XX-UNV  
Report #: 12546460.02  
Delivered Lumens: 2768  
Input Watts: 43.6  
Efficacy: 63lm/W  
CCT: 4000K  
CRI: 93.7

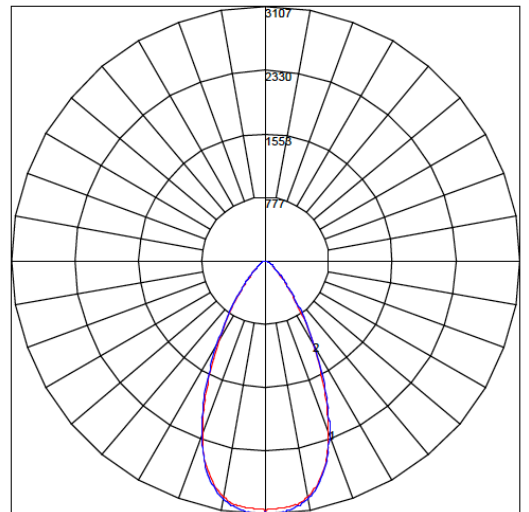

Maximum Candela = 3106.939 Located At Horizontal Angle = 0, Vertical Angle = .5  
# 1 - Vertical Plane Through Horizontal Angles (90 - 270)  
# 2 - Vertical Plane Through Horizontal Angles (0 - 180)

50° Optics / 30% Diffuse Lens / 44W / 3500K

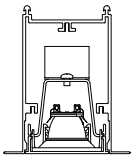

Catalog #: PXL-1B45-935-50-DF-X-04-XX-UNV  
Report #: 12546460.08  
Delivered Lumens: 2875  
Input Watts: 43.6  
Efficacy: 66 lm/W  
CCT: 4000K  
CRI: 93.7

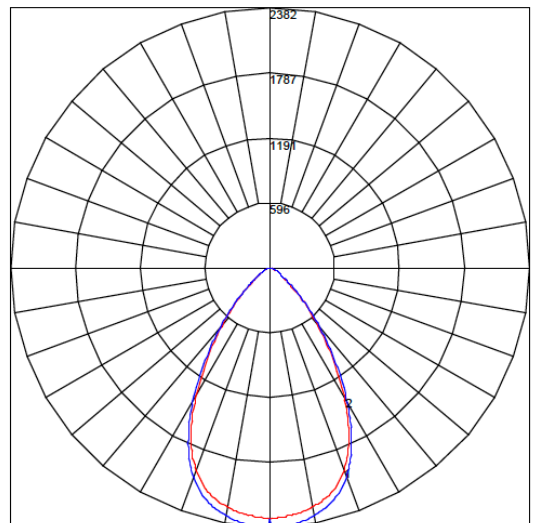

Maximum Candela = 2382.017 Located At Horizontal Angle = 0, Vertical Angle = .5  
# 1 - Vertical Plane Through Horizontal Angles (90 - 270)  
# 2 - Vertical Plane Through Horizontal Angles (0 - 180)

**Photometry**

20° Optics / (XX) No Lens / 44W / 3500K

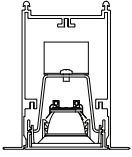

Catalog #: PXL-1B45-935-20-XX-X-04-XX-UNV  
Report #: 12472594.01  
Delivered Lumens: 3429  
Input Watts: 43.6  
Efficacy: 79 lm/W  
CCT: 4000K  
CRI: 93.7

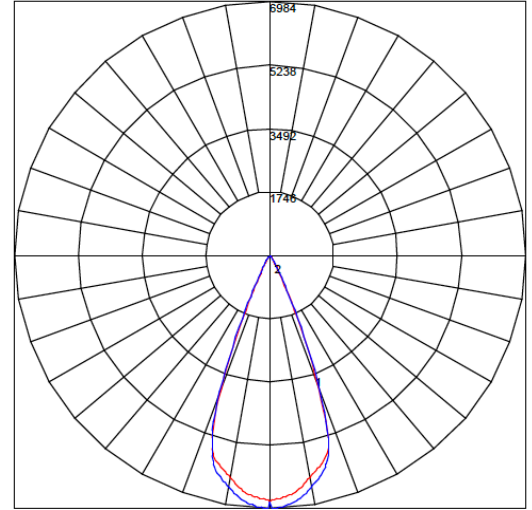

Maximum Candela = 6984.45 Located At Horizontal Angle = 0, Vertical Angle = -5  
# 1 - Vertical Plane Through Horizontal Angles (90 - 270)  
# 2 - Vertical Plane Through Horizontal Angles (0 - 180)

35° Optics / (XX) No Lens / 44W / 3500K

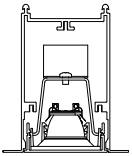

Catalog #: PXL-1B45-935-35-XX-X-04-XX-UNV  
Report #: 12472594.02  
Delivered Lumens: 3995  
Input Watts: 43.6  
Efficacy: 92 lm/W  
CCT: 4000K  
CRI: 93.7

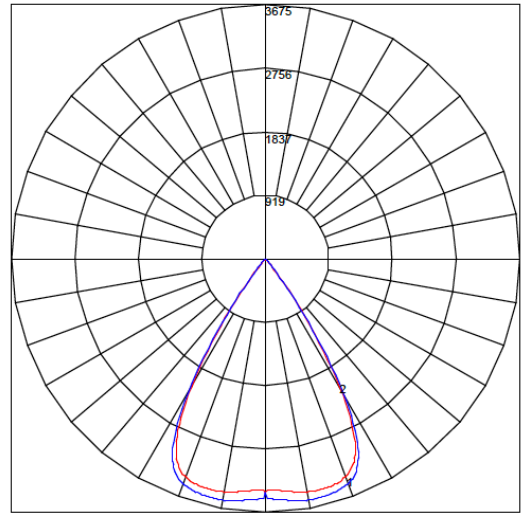

Maximum Candela = 3674.825 Located At Horizontal Angle = 45, Vertical Angle = 24.5  
# 1 - Vertical Plane Through Horizontal Angles (90 - 270)  
# 2 - Vertical Plane Through Horizontal Angles (0 - 180)

50° Optics / (XX) No Lens / 44W / 3500K

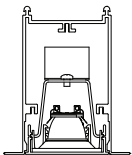

Catalog #: PXL-1B45-935-50-XX-X-04-XX-UNV  
Report #: 12472594.04  
Delivered Lumens: 4199  
Input Watts: 43.6  
Efficacy: 96 lm/W  
CCT: 4000K  
CRI: 93.7

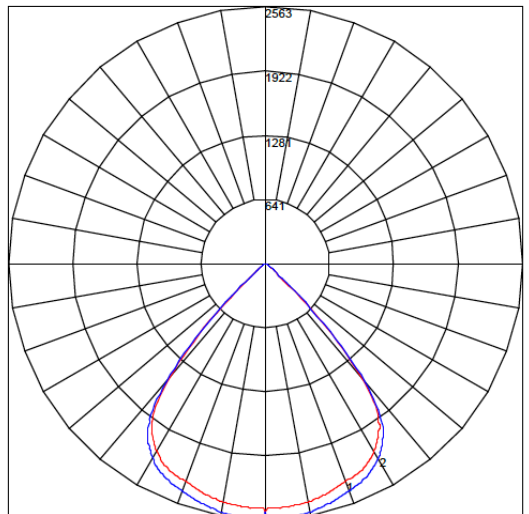

Maximum Candela = 2562.791 Located At Horizontal Angle = 0, Vertical Angle = -5  
# 1 - Vertical Plane Through Horizontal Angles (90 - 270)  
# 2 - Vertical Plane Through Horizontal Angles (0 - 180)

**Photometry**

<b>Piix™ Linear Recessed</b>	
<b>CCT Multiplier*</b>	
4000K	1.000
3500K	0.913
3000K	0.903
2700K	0.903
<b>Direct Lens Multiplier*</b>	
CL	0.84
HX	0.31
DF	0.69
XX	1.00

CCT multipliers apply to the photometry, IES files, and per foot values listed on page 1 (light engine).

Light engine and lens multiplier supplied for per foot values listed on page 1 (light engine).

\* Values calculated from a 4' fixture at 4000K, 90+ CRI using 35° reflector and DIM driver