

selux

M - S E R I E S
L E D

Application Guide





M-Series LED (M-LED) Family

The M-Series LED (M-LED) family combines flexibility, inspiration, and minimalist design, providing individual solutions to unique challenges. Our modular system expands creative freedom so the perfect innovative lighting design can be realized quickly and easily. With stunning solutions that are both intelligent and efficient, the range of possibilities is nearly limitless. M-LED is perfect for a designer looking for a classic line of light that is customizable to their project needs. Use M-LED in offices, hospitality, education facilities, high-end residential, or general task lighting and illumination.

Product Specifications

- Light Engine: Mid-power LEDs · 80+ CRI and 90+ CRI
- Output: Up to 1,618lm/ft · up to 147lm/W
- CCT: 2700K · 3000K · 3500K · 4000K · 3 Step-Binning · Tunable White (2700K - 6500K · 90+ CRI)
- Shielding: LED Optimized White Lens · Clear Lens with Microprism · Symmetric · 20° Wall Washer · 5° Wall Grazer · Direct Batwing · Indirect Wide Batwing (Drop Lens, Light Up Lens, M36 MRC Wall Washer, and Louvers - Specular, Matte Silver, Matte Black, Matte White - available for M36 only)
- Options: Multiple dimming options · Emergency options · Lit Corners · Wet location (M60) · Integrated Piix™ MRC (M100) · Two rows of LEDs (M130) · Separate Switching
- Project-Specific: Blank Covers · Custom Configurations · RGBW · BIOS SkyBlue®

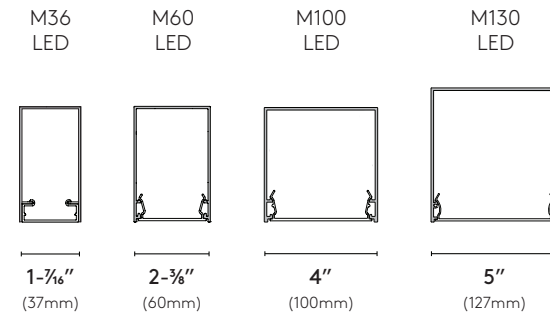



Proprietary LED optical system

allows for impressionable lighting design

Our proprietary LED optical system - Light Modulation Optics (LMO) - has been integrated into the M-LED product family. Designed around the footprint of the M36, LMO can also be incorporated into the other sized fixtures in the range. M36 also goes further by offering additional shielding options including louvers, drop lens, light up lens, and the MRC Wall Washer.

M36 Shielding Options

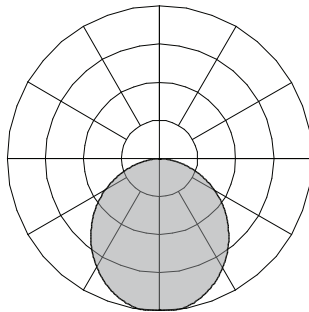

LW - LED Optimized White Lens
(up to 117lm/W)
Application: general illumination

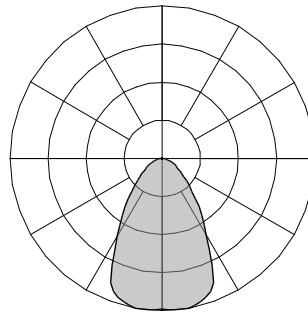

MI - Clear Lens with Microprism
(up to 120lm/W)
Application: low glare, focused task illumination

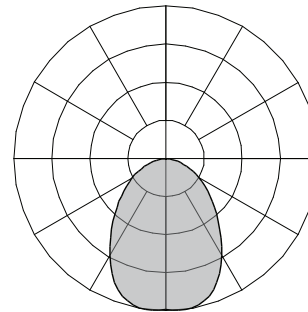

NB - LMO Symmetric
(up to 142lm/W)
Application: general task illumination

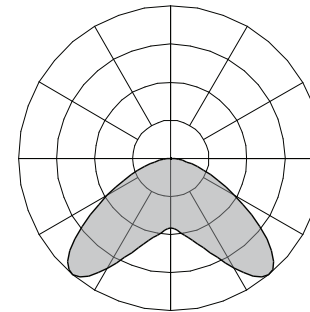

BW - LMO Batwing
(up to 129lm/W)
Application: general illumination, wide spacing

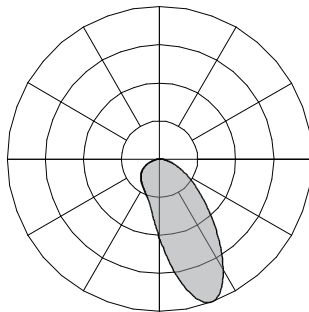

A2 - LMO Asymmetric 20° Wall Washer
(up to 147lm/W)
Application: wall washing

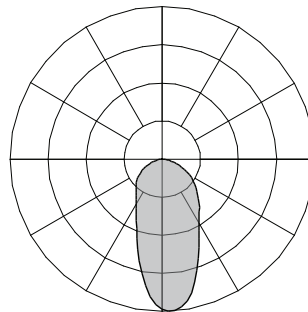

A5 - LMO Asymmetric 5° Wall Grazer
(up to 147lm/W)
Application: wall grazing

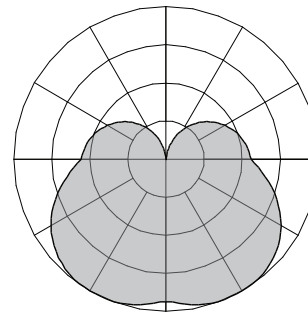

DR - Drop Lens (1-7/8" drop)
(up to 134lm/W)
Application: general and vertical illumination, visual appeal

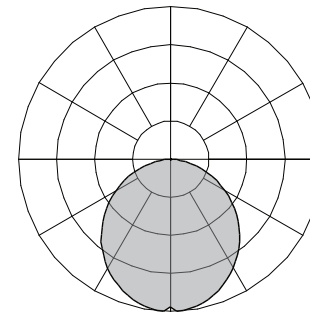

LU - Light Up Lens (1/4" drop)
(up to 121lm/W)
Application: general and vertical illumination, visual appeal

*Values calculated from a 4' luminaire at 3500K and 80+ CRI unless noted otherwise. For complete values, see photometry files online.

Beautiful, high performing luminaires that address glare and uniformity

In M36, louvers and the MRC Wall Washer optics hide the light and reduce visual glare. Both are beautiful, high-performing optical systems that address glare at the source.

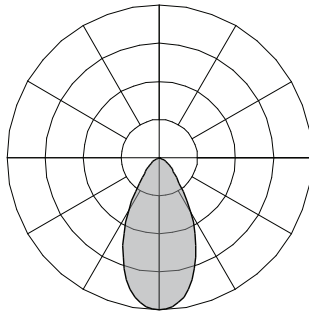

Vx - Louvers

Specular, Matte Silver, Matte Black,
and Matte White finishes available
(up to 96lm/W)
UGR: 13 to 17
Application: low glare, focused task
illumination

*Values calculated from a 4' luminaire
at 3500K and 80+ CRI unless noted
otherwise. For complete values, see
photometry files online.

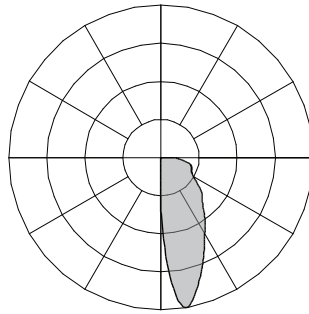

WW - M36 MRC Wall Washer

(up to 80lm/W)
(90+ CRI only)
Application: wall washing

*M36 MRC WW values calculated from a
4' luminaire at 3500K and 90+ CRI. See
photometry files online.



*M36 MRC Wall Washer shown

Add a louver when a **reduction of glare** to the **light source and luminaire** is needed

Our louvers provide a diversity in finishes - Specular, Matte White, Matte Black, and Matte Silver finish. Add a louver when you want to tailor how the light is perceived. Louvers hide the light source and create visual comfort when near.



Matte Black shown

Versatile optics

integrated for more uniform appearance

Our successful and versatile M36 LED optics have been integrated into the M60 LED and M100 LED products as well. All of the proprietary Light Modulation Optics (LMO) are tucked behind a Satine Lens for a more uniform appearance and illumination to the top of the wall without protruding from the ceiling. M60 LED and M100 LED are also available with the proprietary indirect Wide Batwing optic.

M60 and M100 Shielding Options

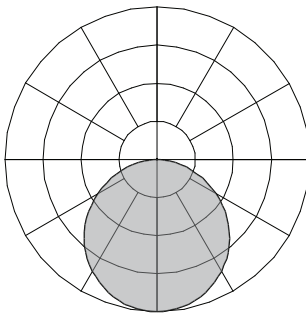

LW - LED Optimized White Lens
(up to 102lm/W)
Application: general illumination

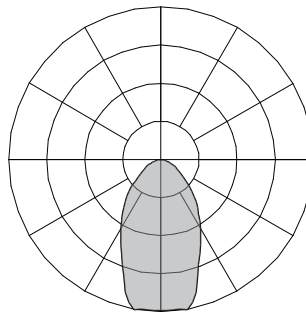

MI - Clear Lens with Microprism
(up to 119lm/W)
Application: low glare, focused task illumination

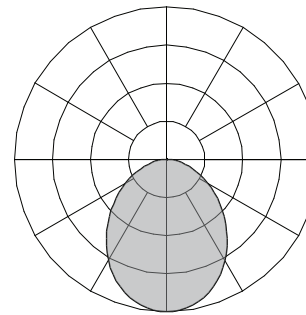

NB - LMO Symmetric
(up to 110lm/W)
Application: general task illumination

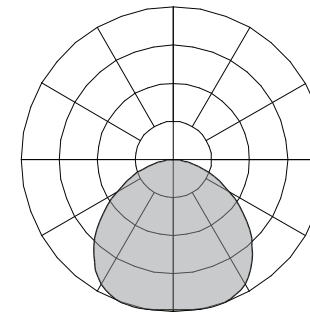

BW - LMO Batwing
(up to 102lm/W)
Application: general illumination, wide spacing

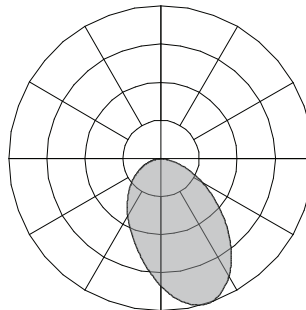

**A2 - LMO Asymmetric
20° Wall Washer**
(up to 111lm/W)
Application: wall washing

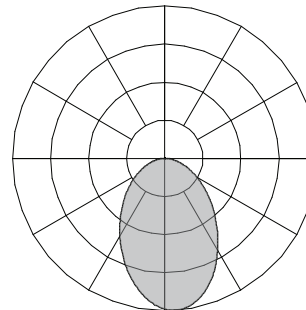

**A5 - LMO Asymmetric
5° Wall Grazer**
(up to 112lm/W)
Application: wall grazing

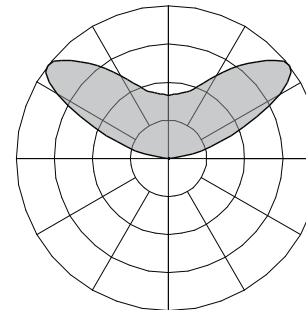

WB - LMO Wide Batwing
(up to 139lm/W)
Application: indirect wide spacing

Designed to accentuate your ceiling with uniform brightness

High Performing Indirect Wide Batwing

The indirect Wide Batwing has been specifically designed to enhance the architectural environment by providing a beautiful and uniform ceiling wash. It's available in the M36, M60, and M100 form factors.

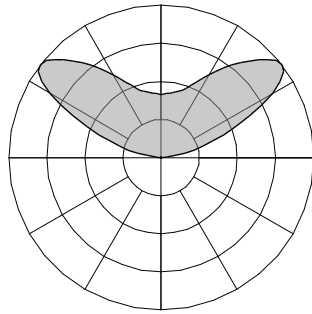

WB - LMO Wide Batwing
(up to 139lm/W)
Application: indirect wide
spacing

Wide batwing optic

The low angle Wide Batwing Optic spreads light across the ceiling, creating a superior ceiling uniformity, and is extremely efficient at up to 139lm/W.

Achieve maximum uniformity on the ceiling

Reduce contrast on the ceiling with the Wide Batwing optic, even when there is limited space between the ceiling and the luminaire. With a wider spacing, fewer luminaires are needed to light a space.

Improved visual comfort

Create a sense of spaciousness, eliminate veiling reflections, reduce eye fatigue, and support facial recognition through indirect lighting.

Minimize glare

Provide useful illumination within a space without the added direct luminous glare.

Analysis of the Indirect Wide Batwing

The photometric analysis compares the LW - LED Optimized White Lens to the WB - LMO Wide Batwing. Both scenarios produce similar average illuminance values and uniformity ratios (Avg/Min) on the workplane, but the Wide Batwing achieves an excellent ceiling uniformity (Max/Min).

L36DI-1C20-1C25-935-LW-LW

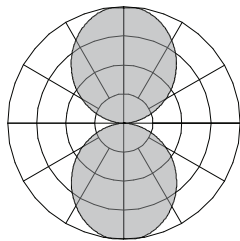

Direct Lumen Output: 429lm/ft
 Indirect Lumen Output: 535lm/ft
 CRI: 90+ (High Color Rendering)

The Workplane:

Avg. Illuminance: 35fc
 Uniformity Ratio (Avg/Min): 1.69

The Ceiling:

Avg. Illuminance: 32fc
 Uniformity Ratio (Max/Min): 9.55

L36DI-1C20-1C20-935-LW-WB

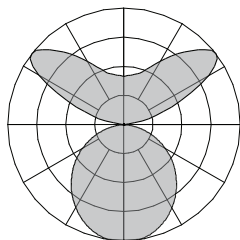

Direct Lumen Output: 429lm/ft
 Indirect Lumen Output: 509lm/ft
 CRI: 90+ (High Color Rendering)

The Workplane:

Avg. Illuminance: 34fc
 Uniformity Ratio (Avg/Min): 1.68

The Ceiling:

Avg. Illuminance: 30fc
 Uniformity Ratio (Max/Min): 4.68

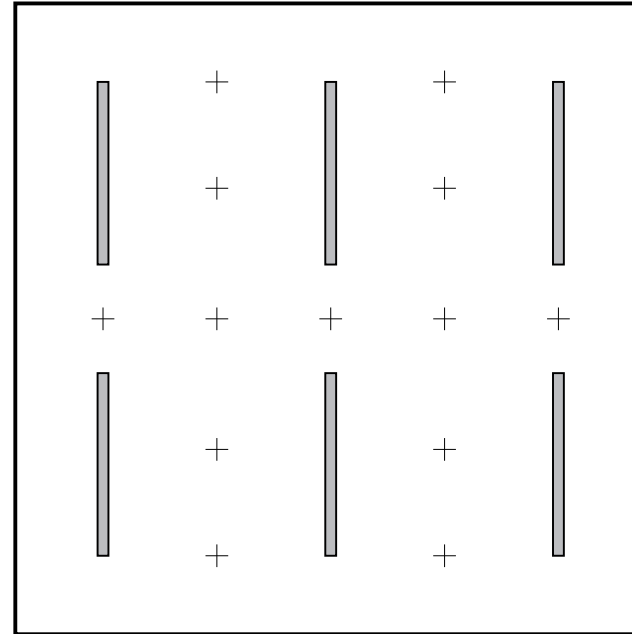

Room Characteristics:

Room Size: 36' x 36' x 12'
 12' Luminaire Lengths
 Luminaire Suspension Distance: 3' (36")
 Luminaire Spacing: 14' x 18'

Reflectance Values: 80/50/20
 LLF: 0.90

Wall Washing

Highlight a wall to create interest or enhance the smoothness and eliminate shadows with wall washing optics.

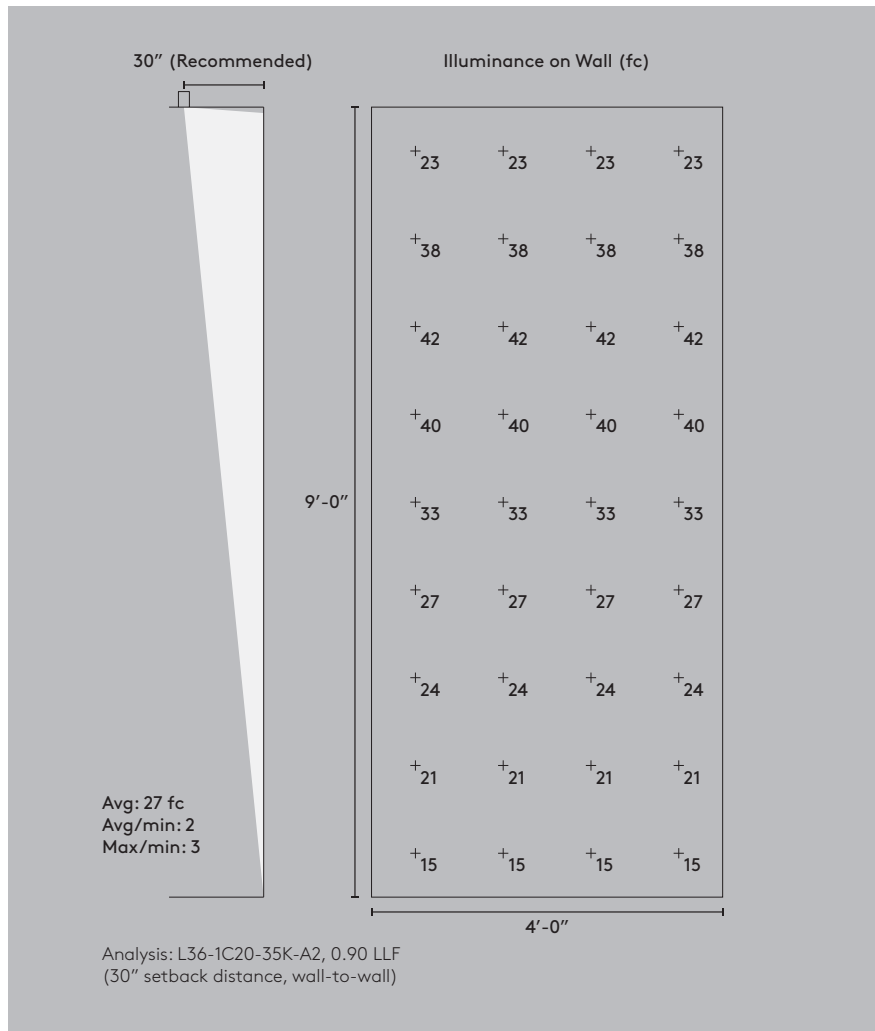

The A2 - LMO Asymmetric 20° Wall Washer provides high quality optical performance, translating into an even distribution of light on the wall.

Oliver's Yard, London, United Kingdom Photo courtesy of James Newton

Wall Grazing

Accentuate textures or features on a wall and create dramatic lighting effects with wall grazing optics.

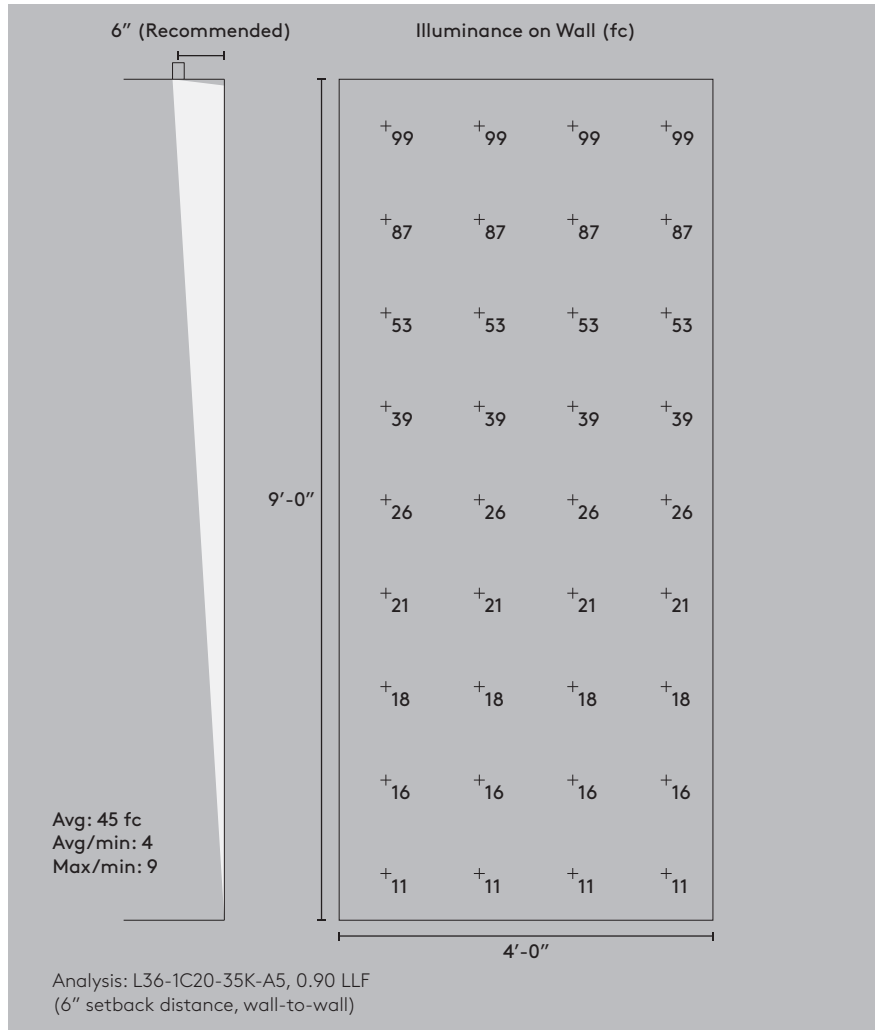

The A5 - LMO Asymmetric 5° Wall Grazer is designed to create a tight, focused beam, evenly illuminating textures and highlighting accent walls to promote visual interest.

Oliver's Yard, London, United Kingdom Photo courtesy of James Newton

General Illumination creates high-performance lighting
with exceptional quality



School of American Ballet, New York, New York Photo courtesy of Diller Scofidio + Renfro/Iwan Baan



Configurations

allow for artistic freedom

M-LED expands creative freedom so innovative lighting design can be realized to the fullest extent. Create a unique statement piece, increase visual interest, or follow unique

architectural lines by using M-LED custom configurations. Consult the factory for your project-specific application needs.



BMO Bank of Montreal - First Canadian Place; Photographer: Steve Tsai Photography



950 17th Street, Denver, CO; Photographer: Koerbel Photography

Custom M-LED Application



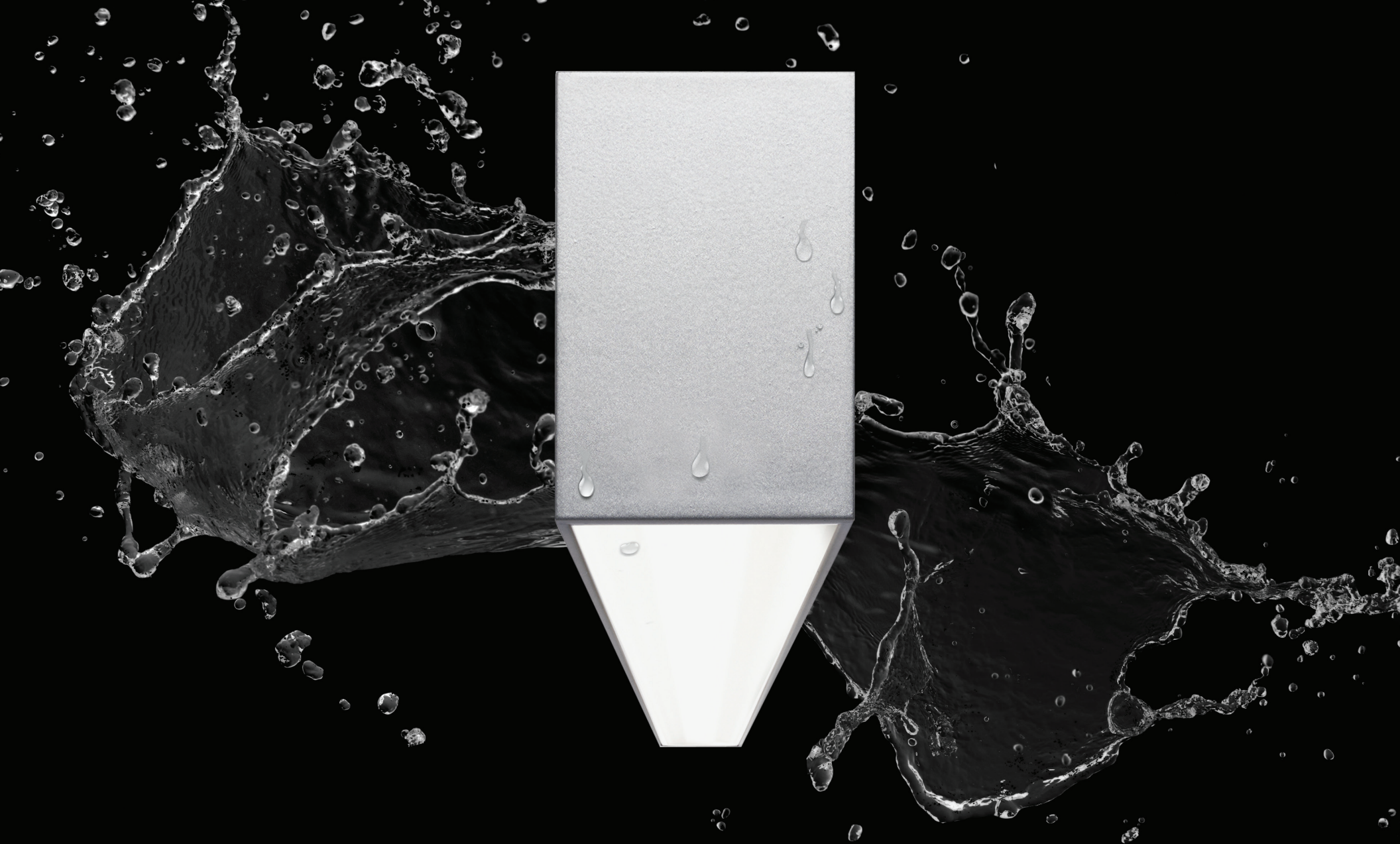

When damp location isn't enough
use **Wet Location M60** to provide extra protection
from the elements

Wet Location M60

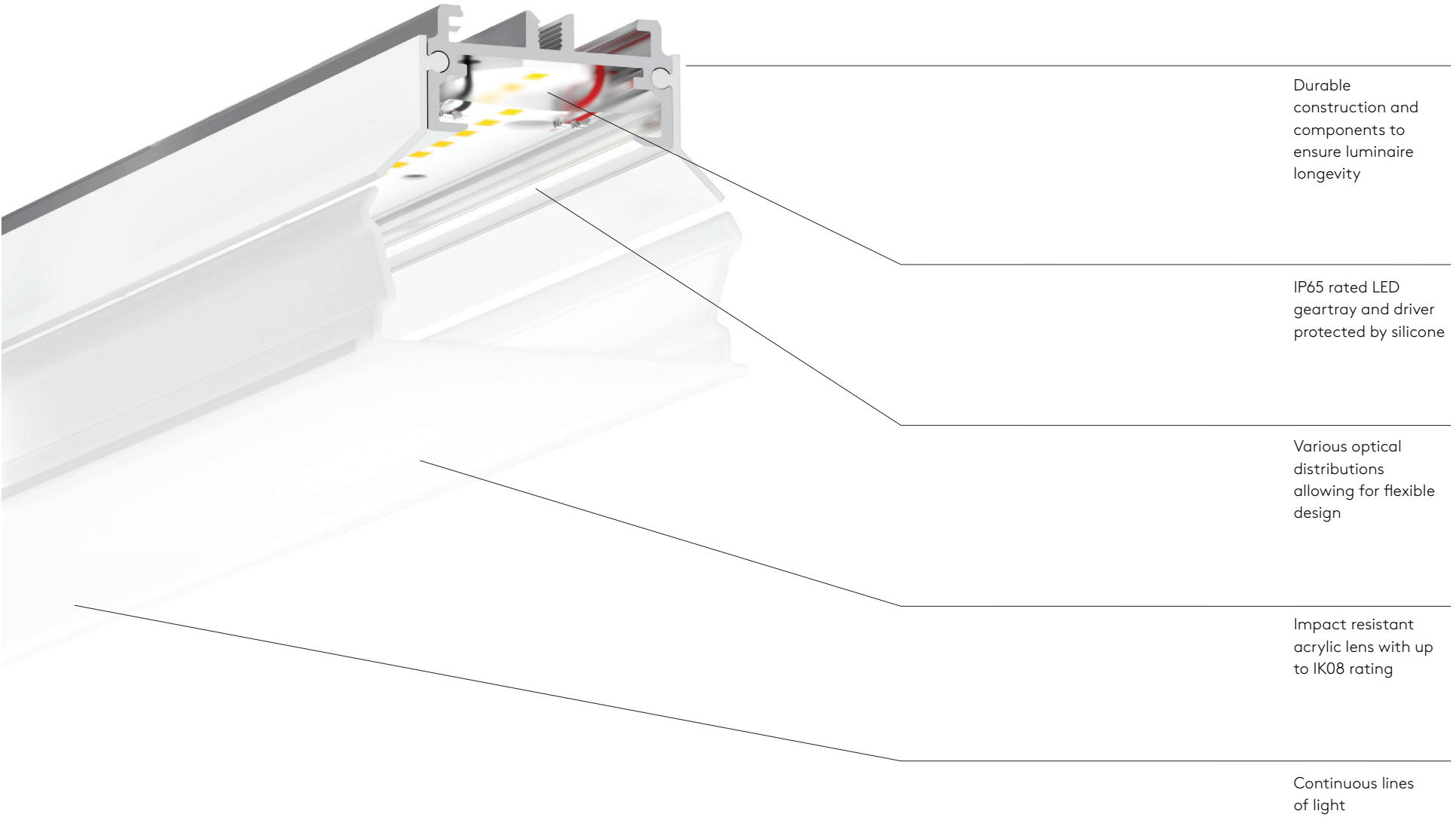
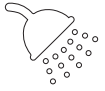

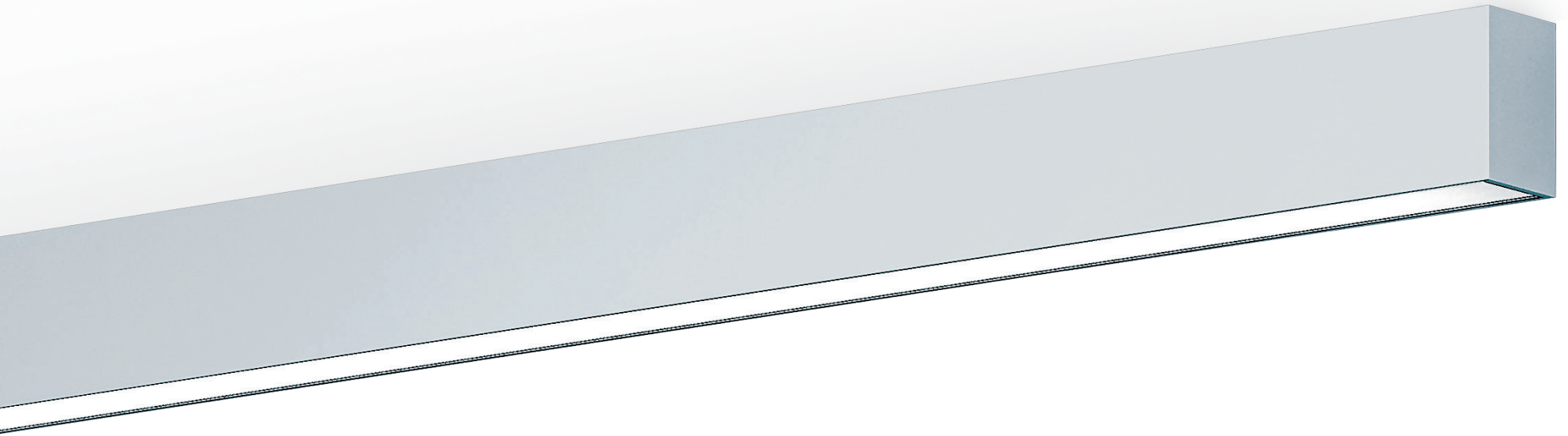

**Wet Location M60 allows you to create
engaging lighting layouts with any
length of continuous light,
seamlessly integrated with the
architecture**

Wet Location M60 is the same dimensions, quality, and aesthetics as our M60 interior fixture, but has the added protection from the elements. The geartray and driver are both protected with silicone, which ensures fixture longevity and added protection of the LEDs and components.

Wet Location M60 provides the flexibility to create individual lengths or long, linear runs with the same ease as our standard M60 product. Even corners and configurations are possible - consult factor for non-standard corners.

Product Specifications

Light Engine:	Mid-power LEDs · 90+ CRI (80+ CRI consult factory)
Output:	Up to 973lm/ft · up to 101lm/W
CCT:	3500K · 4000K · 5000K · 5500K
Shielding:	LED Optimized White Lens · Clear Lens with Microprism · Symmetric · 20° Wall Washer · 5° Wall Grazer · Direct Batwing
Options:	Multiple dimming options · Emergency options · Lit Corners · Separate switching · Suitable for Natatoriums
Project-Specific:	Configurations · Sensors (by others)

Wet Location
M60



2-³/₈"
(60mm)

Wet Location M60



Brookfield Zoo, Brookfield, IL - Photographer: Jenling Norman

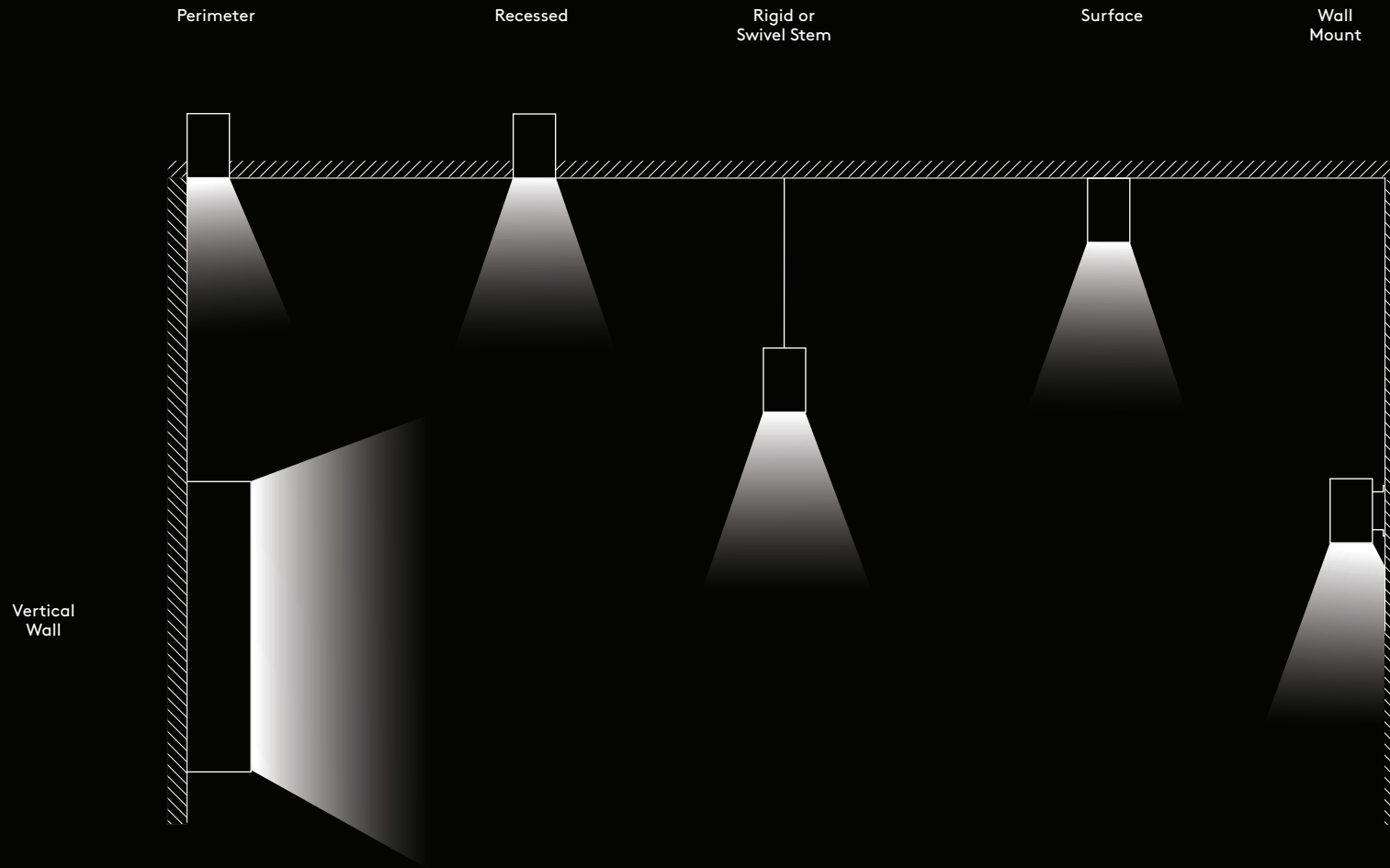

Offering a wide range of mounting options, providing solutions for demanding environments

*Not suitable for recessed wall mount, horizontal surface/wall mount with light pointing out, or indirect lighting.

Wet Location M60 configuration







Pittman and Dowell Residence, La Crescenta, California - Photography: Iwan Bann

M-LED Recessed Perimeter lights sit above the ceiling plane and provide an excellent light source around the perimeter of the room

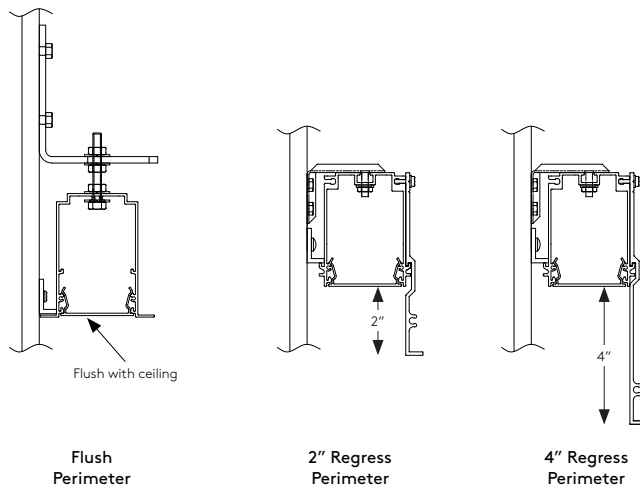

Recessed Perimeter

Create a continuously illuminated slot - including fully luminous corners - with recessed perimeter mounting. Choose from flush, 2" regress, or 4" regress depths in the M36, M60, or M100 series luminaires. Available with spackle flange or flanged mounting.

Adjustable Geartray and Field-Cutttable Housing

Adjust to walls of any length with the adjustable geartray and field-cutttable housing. Standard with +/- 6" field adjustability, you can worry less about the designed space being built precisely as planned, and can change your light fixture as needed during installation. (Field adjustability not available with Wet Location M60.)

Choose from a variety of the standard M-LED optics to create the desired illuminating effect on the vertical surface.



Make your room appear more spacious without an obtrusive fixture

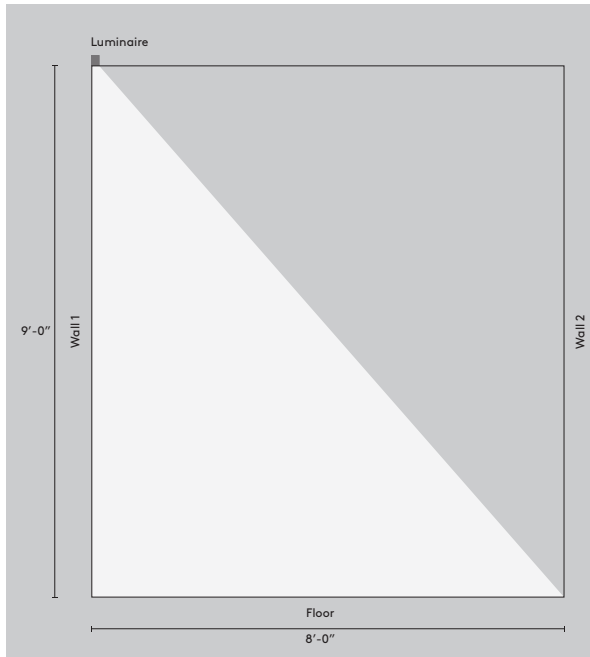

HVB Tower Munich, Germany; Photographer: Henn Architekten/Hans-GeorgeEsch

Corridor Fill with Perimeter Mounting

Use the A2 - LMO Asymmetric 20° Wall Washer optic aimed away from the wall to provide corridor fill light with perimeter mounting. This allows for exceptional lighting in the corridor while reducing installation costs and energy usage compared to standard cove applications.

Corridor Characteristics:

Corridor Size: 8' x 9'

Reflectance Values: 80/50/20

LLF: 0.90

Luminaire	Output (lm/ft)	Avg. Illuminance on Floor (fc)	Uniformity Ratio on Floor (Max/Min)	Avg. Illuminance on Wall 1 (fc)	Uniformity Ratio on Wall 1 (Max/Min)	Avg. Illuminance on Wall 2 (fc)	Uniformity Ratio on Wall 2 (Max/Min)
L36-1C20-835-A2	642lm/ft	46fc	2.31	29fc	12.83	21fc	2.62
L60-1C25-835-A2	642lm/ft	41fc	2.34	35fc	15.31	21fc	2.54
L10-1C25-835-A2	600lm/ft	39fc	2.27	34fc	16.52	20fc	2.45

Taking on new form M-LED is available in standard geometric shapes

M-LED Shapes standardize on the most popular requests
- Triangle, Square, Rectangle, or Hexagon. Shapes are
available with Recessed, Surface, or Pendant Mounting in
M36, M60, or M100. All shapes come standard with 1', 2', 3',
and 4' leg lengths. For other shapes or sizes, please consult
the factory.



My White provides adjustability in the amount and color of your light creating a comfortable environment

Humans have an internal clock that affects everything from sleep patterns to productivity to health. This clock is called the circadian rhythm. As humans evolved in the days before electric lighting, they had natural exposure to various levels (both color temperature and intensity) from the sun. By adjusting electric lighting to mimic the natural hue and intensity of the sun, it can help restore the body to a natural state. Various studies have shown that this can help with alertness, behavioral issues, and

productivity. The Selux proprietary My White technology allows you to adjust both the amount and color of your light, creating a comfortable environment for healthcare, corporate offices, educational facilities, hospitality, or any other installation where varying color temperature could benefit the occupants. Set up the My White luminaires to a whole building solution, and you could create an automatic adjustment to the light to mimic daylight.

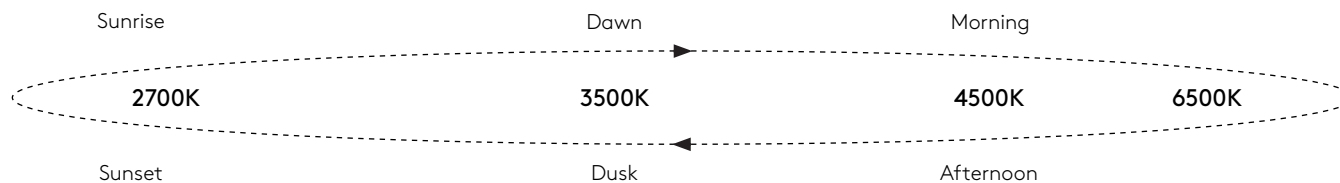
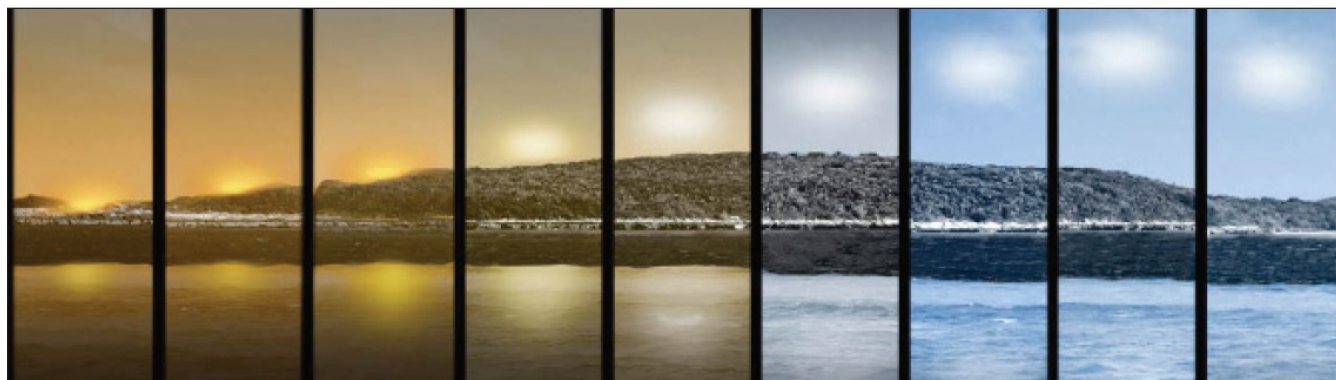

selux + bios For M-LED with Bios SkyBlue®, consult factory.

Selux Metal Finishes

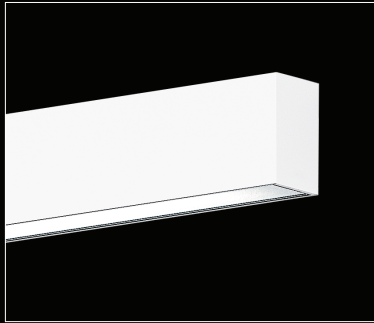

White
(WH)

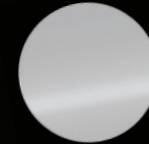
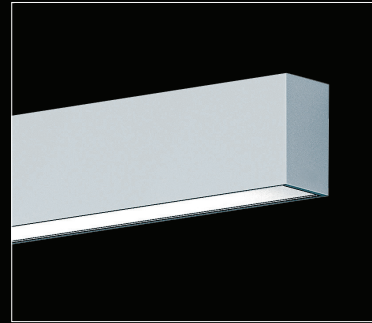

Silver
(SV)

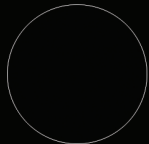
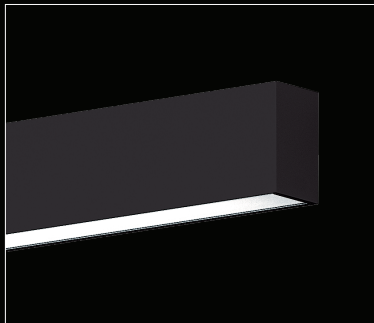

Semi-Matte Black
(BL)

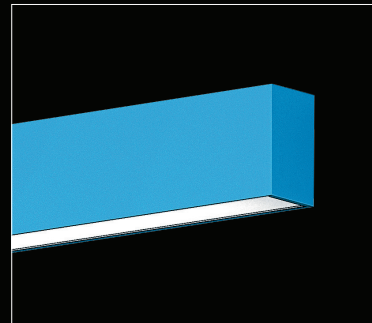

Custom RAL finish
(SP)



Separate Switching

Luminaires available with separately switched (nominal) sections starting at 7' and up. Luminaire is intended to be wired to the same panel/breaker (not intended for emergency use).



Configurations

Create comfortable and aesthetically pleasing rooms with custom configurations. M-LED can help set the mood, emphasize architectural features, and highlight artwork and other decorative elements. Lit horizontal 90° corners - X, Y, and T configurations are available and cut to the precise length you are looking for.

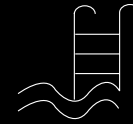

Suitable for Natatorium Environments

Natatorium environments create extremes in temperature, humidity, evaporation, vapor pressure, and multitude of other factors. Wet Location M60 can withstand harsh vapors and humidity while maintaining its original corrosion-free form. Consult factory for details.



Wet Location

Wet Location M60 designed to withstand direct exposure to indoor and outdoor elements like rain and snow. The liquid may splash, drip, or flow on the luminaire without worry of damaging the electrical components of the fixture. This fixture can be used in shower enclosures, steam rooms, on exterior walls, or outdoor walkways.



Sensors

With capabilities like motion or vacancy sensing as well as more advanced information tracking, sensors in M-LED allow for complete control of the lighting and the installed space. We have several standard sensors right on our product spec sheets, or can incorporate others for project-specific needs – just consult the factory with your request!





Publisher

Selux Corporation
5 Lumen Lane
Highland, NY 12528
www.selux.us

Edited by (responsible)

Selux Corporation

Concept and Design

Selux Corporation
www.selux.us

Print

Selux Corporation
5 Lumen Lane
Highland, NY 12528

Selux is a registered trademark of the Selux Corporation.
Errors accepted and subject to change due
to technical modifications. For conditions of sale
and delivery please refer to www.selux.us.

The use of the text and images, even in part, is
in breach of copyright without the consent of
the Selux Corporation and punishable. This also applies to
copies, translations, microfilming and processing
with electronic systems.

March 27, 2023 3:28 PM