

L I G H T I N G F O R E D U C A T I O N

Application Guide



Interior and Exterior

selux



Important elements of effective school lighting



Lighting for Safety

Lighting is crucial throughout school campuses to ensure student and staff safety and prevent accidents. Having a safe place to study and grow enhances the learning environment and improves outcomes.



Health & Well-being

Good lighting can enhance moods, improve alertness, and boost student performance. Many aspects should be considered in order to promote health and well-being throughout schools.



Academic Performance

Proper lighting in schools is important for academic performance as it helps students focus, reduces eye strain, and supports well-being.



Sustainability

Sustainable lighting solutions can lower energy consumption and decrease operational costs as well as foster a healthy, productive learning environment.

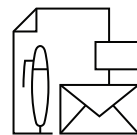

Brand Identity

Selux lighting can be used to emphasize school identity, showcasing logos, slogans, and colors. This helps foster a strong sense of community and pride within the institution and aids in attracting potential students and their parents.

Lighting for Safety

Uniformity

People feel safer in evenly lit indoor and outdoor environments. Selux interior and exterior luminaires with advanced optical designs can be used to create uniform layouts that reduce shadows and dark spots, allowing students and faculty to feel safe on campus or in classrooms.

Low Glare

By allowing people to see their surroundings clearly without being blinded by glare from harsh lighting, they will feel safer. Selux low-glare technology puts light where it needs to be, creating a visually comfortable and safe user experience.

Facial Recognition

Being able to clearly identify individuals who approach and assess potential threats is another key ingredient for creating a safe academic environment.



MHL125

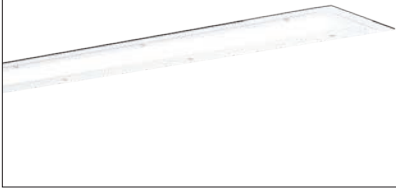

Arca Pro

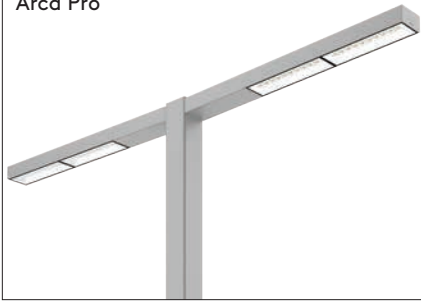

M125



SteelCore Bollards

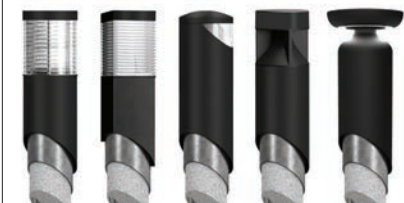

SAFETY



Recommended Lighting

Even Distribution

Navigate school premises and enhance visibility

Emergency Lighting

Help guide students and faculty safely

Smart Lighting

Improved illumination and remote controlled monitoring

Glare Control

Reduces the risk of accidents and improves navigation

Impact Rated

IK10 for areas subject to abuse and vehicular-impact to protect students, staff, and visitors

Ligature-resistant

minimizes risks in on-campus mental health facilities or specialized education spaces



SAFETY

Inula



Ouray®



Exelia



Melli™ Sistema





Spelman College



Health and Wellness

Color Tuning

Color tuning, particularly the wavelengths of light, affects our sleep-wake cycle. High-intensity blue light reduces melatonin and keeps us alert, while warm red light encourages relaxation and sleep. Circadian lighting systems adjust light color and intensity during the day to align with natural rhythms. Selux My White uses advanced tunable white technology, allowing digital control of color temperature all day. It improves interior lighting with design flexibility and various dimming options for enhanced control.

Dimming

Controlling light brightness is crucial for student health and well-being as it helps prevent eye strain, headaches, and fatigue, which can hinder concentration and productivity. Proper lighting also supports circadian rhythms, improving sleep quality and enhancing mood and cognitive performance throughout the day.

Low Glare

Low glare lighting reduces eye strain and discomfort, which can help prevent headaches and improve focus. It also promotes a more calming environment, contributing to better mental health and overall well-being.



Cool

Warm

MY WHITE

COLOR TUNING

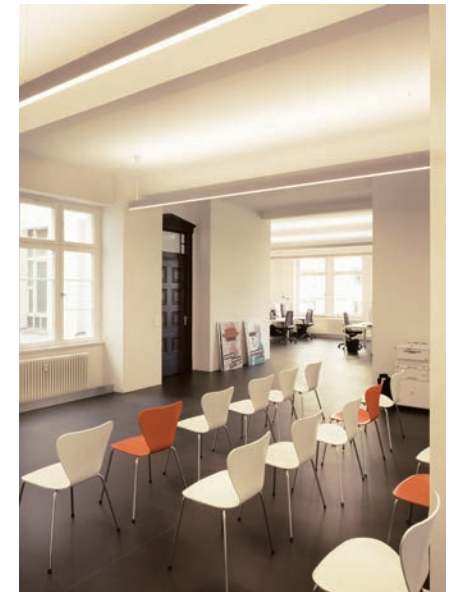
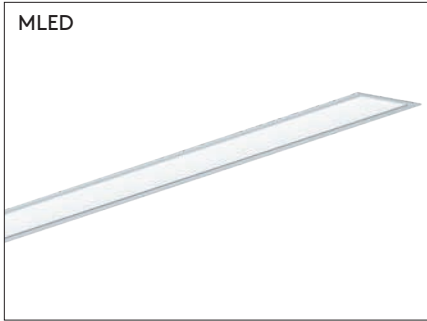

Recommended Lighting

Enables human centric lighting
improving learning and performance

Helps optically zone architecture
creates a conducive learning environment

Creates perceptual hierarchies
can delineate learning zones

Emphasizes key elements
draws students' attention

Highlights materials and features
makes diagrams and charts more visible

WELLNESS & SUPPORT SPACES

MHL125



MHL125



Recommended Lighting

Minimizes risk of self-harm
through ligature prevention

IK10 Rating reduces hazards
from broken or damaged fixtures

Creates a safer environment
for both occupants and staff

Design without compromise
non-institutional aesthetics with faux wood

Human-Centric Lighting
supports mood regulation

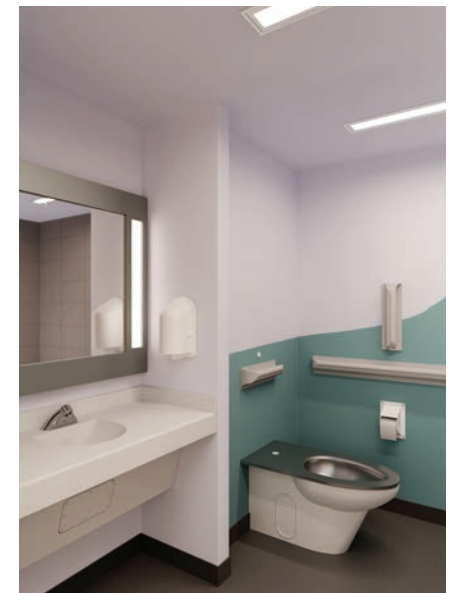

MLED



MLED Recessed Perimeter



Purelight



Piix



LOW GLARE

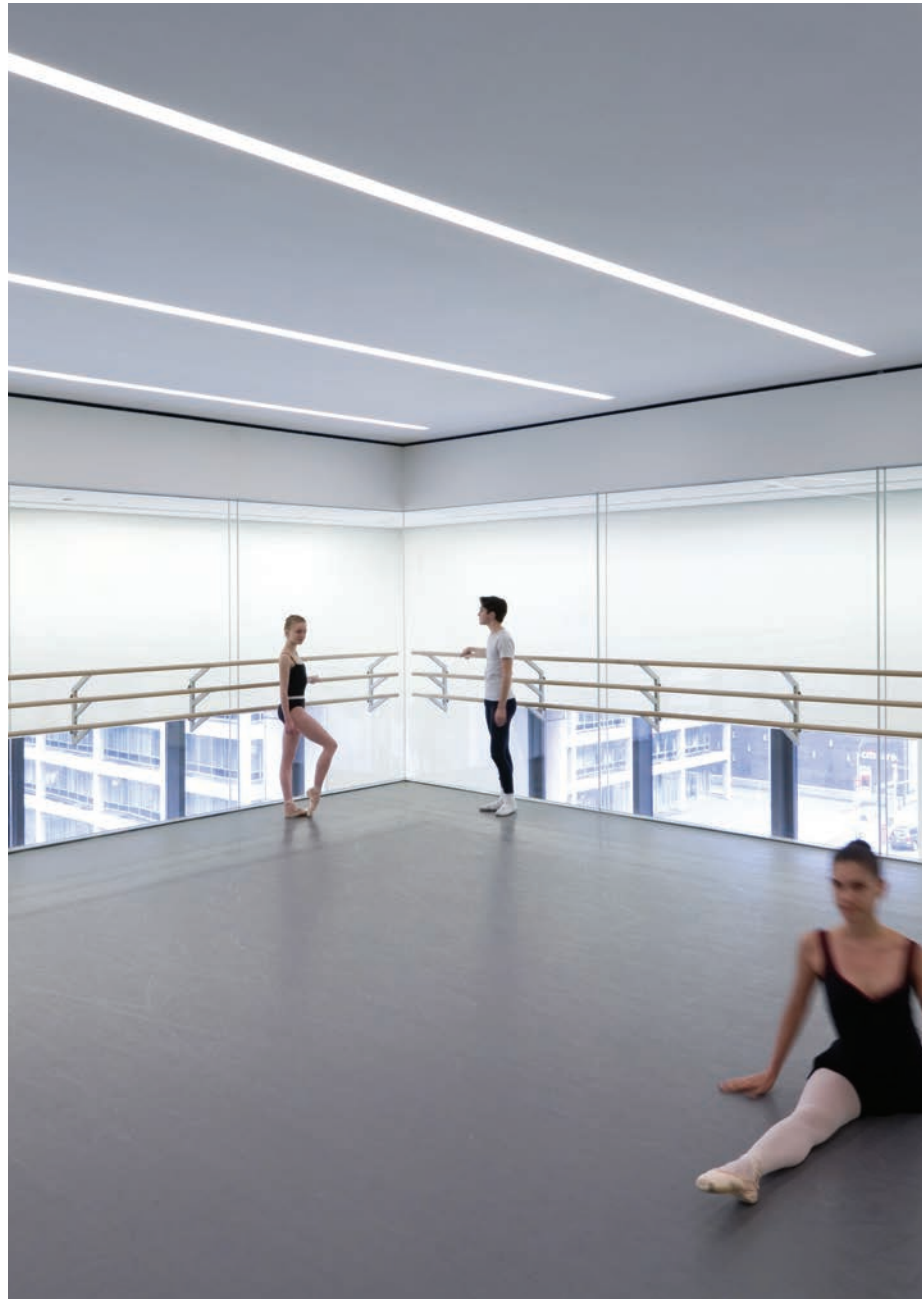

Academic Performance

Light Levels

Effective lighting is essential for academic success among students. It profoundly affects their ability to focus, their cognitive functions, and their overall health. Sufficient light, particularly natural illumination, boosts alertness, reduces eye fatigue, and cultivates a positive learning environment. These elements collectively support student well-being, optimize concentration, and ultimately contribute to enhanced academic performance.

Lighting Quality

High-quality light - without noticeable flicker, with high CRI, and appropriate CCT - will create a more stable and conducive learning environment, particularly for students sensitive to visual disturbances.

Acoustic Material

Integrate sound absorption with lighting to enhance overall comfort. Acoustics play a role in student performance by reducing distractions and ensuring clear communication, which enhances focus and comprehension during lessons. Proper acoustic design also helps maintain a comfortable noise level, supporting cognitive function, reducing stress, and creating an optimal learning environment.



ACADEMIC PERFORMANCE

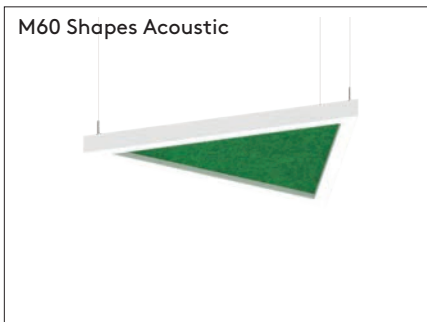
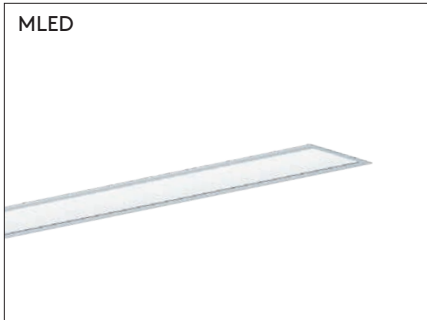

Recommended Lighting
<p>Low UGR For reduced eye strain</p>
<p>High TM-30 Gamut Makes colors vibrant</p>
<p>90+ CRI High color rendering brings visuals to life, amplifying learning</p>
<p>Geometric Shapes Bring play into learning</p>
<p>Acoustic Material Reduce distractions to help improve concentration</p>



Sustainability

Sensors and Smart Devices

Sensors and smart devices automatically adjust light levels based on occupancy or natural light, reducing energy consumption when spaces are unoccupied or sufficiently lit. This smart energy management helps reduce utility costs, lower carbon footprints, and promote sustainability by ensuring resources are only used when needed.

Declare Label

The use of products with a Declare label supports a university's sustainable story by ensuring transparency in material sourcing and reducing harmful environmental impacts, contributing to healthier indoor environments for students and staff. By choosing these products, universities can align with green building standards and demonstrate a commitment to sustainability in their campus infrastructure.

Solar Power

Solar powered lighting significantly reduces a university's reliance on grid electricity, lowering energy costs and decreasing its environmental impact. By harnessing renewable energy, it supports sustainability goals, reduces carbon emissions, and can save on installation costs in remote campus areas because wiring does not need to be run to solar lights.



SUSTAINABILITY

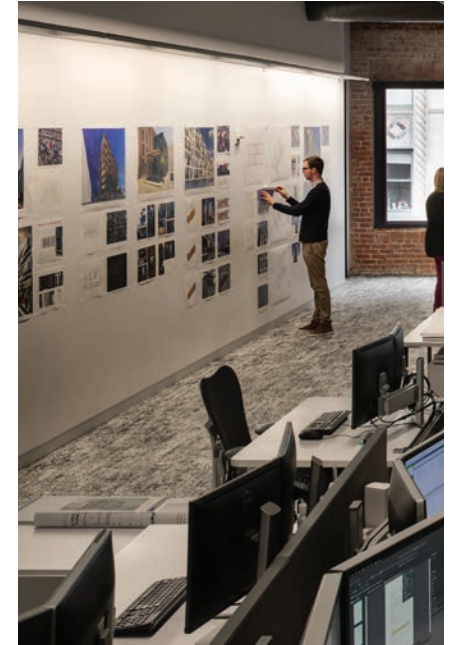

Recommended Lighting

Environmental Impact

Reduce energy consumption

Sensors and Dimming Control

Ensuring areas are adequately lit at night

DarkSky

Helps preserve the night sky, protecting wildlife

Declare Listed

Contributes to sustainable building practices and long-term cost savings

SOLAR

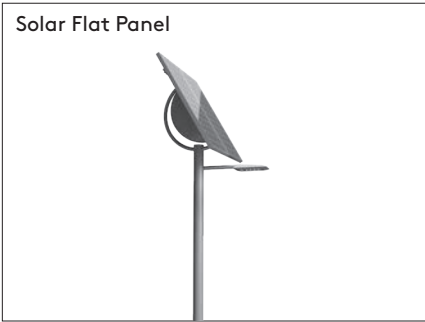

Recommended Lighting

Customized Sizing

Choose the right amount of solar panels, distribution, and pole spacing for campus areas

Sensors and Dimming Control

Combine sensors with solar to reduce the amount of stored light used when it is not needed

Durable

Reduces maintenance costs

Efficient

Technical optics provide efficient light, so the stored energy is used to light when needed

Enhanced Safety

Provides a reliable source of power during grid outages



Brand Identity

Light Pole Banner Arms & Wayfinding

Selux offers custom pole solutions including options like banners, which visually reinforce the school's identity through consistent design and messaging. These solutions can also aid in wayfinding by providing clear directions and highlighting key areas, making it easier for students, staff, and visitors to navigate the campus.

University Colored Poles & Modular Columns

The exterior lighting is one of the first things you see when entering a campus. Make a statement by showcasing school colors through custom light poles. These elements help convey a university's brand identity by creating a cohesive and recognizable campus atmosphere. This visual consistency reinforces the institution's values, enhances school spirit, and promotes a strong sense of community.

Shapes & Colors

Custom shapes or colored light fixtures can incorporate distinctive design elements and school colors that reflect its unique culture and values. This visually engaging approach helps create memorable spaces that foster school pride and make the campus more recognizable to students, visitors, and the community.



BRAND IDENTITY

MLED Shapes and Acoustics



Olivio Gobo



Modular Column



VAZ



Recommended Lighting

On-brand Finishes

Whether your school colors are subdued or bold, enhance the space by showing off school pride

Custom Configurations

Customize fixtures with unique shapes, colors, and school branding

Cohesive Visual Experience

Create a memorable experience and enhance brand recognition through the lighting design

Projected Images

Use GOBO projectors to have seasonal or event-specific images projected throughout your space

Community Pride

Promote the school and generate an emotional connection to the community

Quality and Stature

Using high-quality materials and products helps show off the pride and care of your school





CENTER FOR GLOBAL STUDIES
AND HUMAN DEVELOPMENT

The Center
for
Global Studies and
Human Development

CLASSROOMS

M60 LED Shapes Acoustic



M100 Direct/Indirect



M36 Combo



Piix™

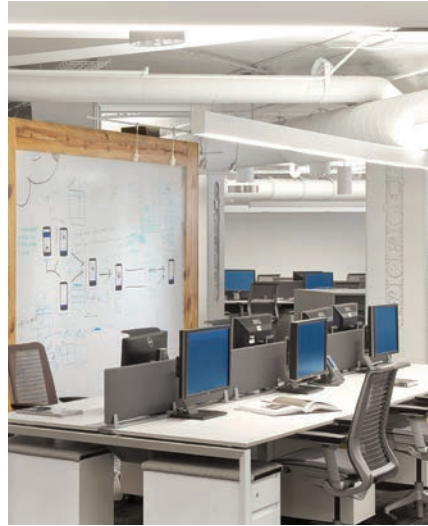

Recommended Lighting

Energy Efficient

reduces energy consumption

Lighting with Longevity

LEDs reduces the need for frequent maintenance and replacements

Color Tunable

gives teachers more control over the learning environment

Task and General Lighting

makes it easier for students to focus

Sound absorption

enhances speech clarity, improving better communication



AUDITORIUMS & LECTURE HALLS

MLED

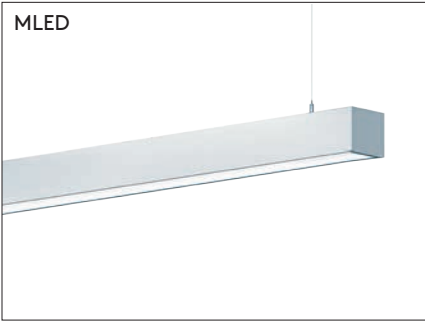

MLED for Technical Ceilings



Melli™



Piix™ MRC



Recommended Lighting

Optimal Uniformity

Use comfortable, uniform lighting for audience enjoyment

Controlled Output

Digital controls and dimmers vary atmospheres

Efficiency

Use sensors to control lighting usage effectively

Minimized Glare

Use glare-reducing optics for better visibility

Lighting for Safety

Ensure safety and security for spectators during performances

LIBRARY



MLED



Linear Configurations

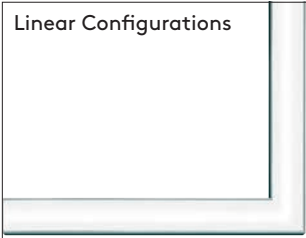

Piix™ MRC



M36 Combo



Recommended Lighting

Layered Lighting

Utilizes ambient, task, and accent lighting

Dimmable

Shifts from a bright, energetic space to a softer, subdued space for study

Wall Washing

Provides a well-lit surface to showcase and draw attention to artwork or displays

Sound Absorption

Minimizes noise and reduces echo

Glare Control

Reduces eye strain and fatigue when reading



COLUMBINE LIBRARY

ATHLETIC FITNESS

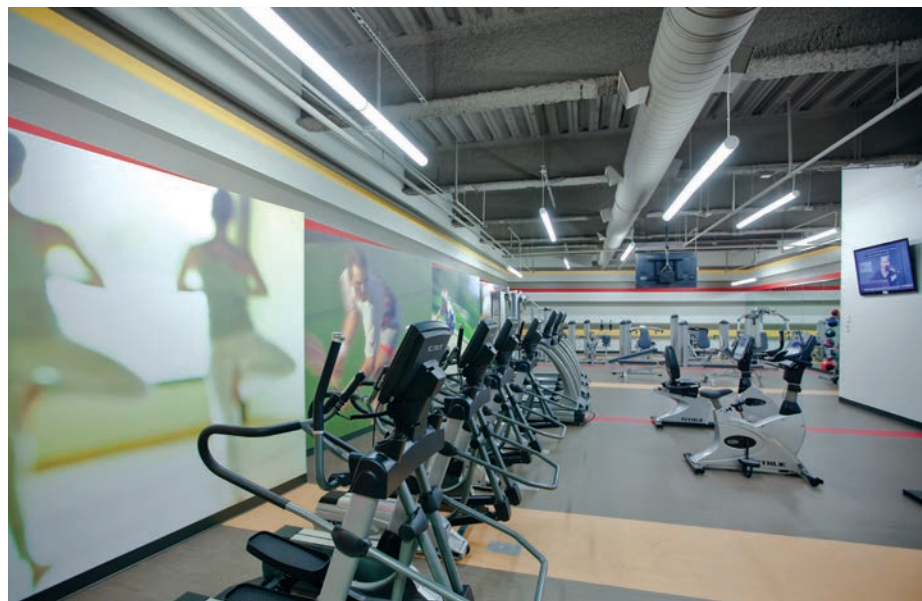
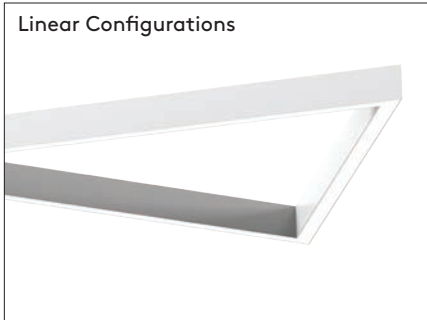

Recommended Lighting

Versatile

A variety of lighting schemes to be implemented and adjusted to suit various needs

Minimized Glare

Reduces the risk of accidents and enhances focus

Vandal Resistant

Reduces maintenance costs and improves playability and durability of the facilities

Energy Efficient

Reduces environmental impact

Cooler Color Temperatures

Creates a more vibrant, engaging atmosphere

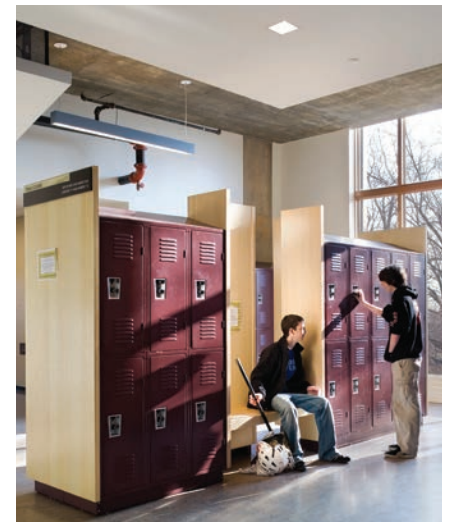

MLED



M36 MRC Wall Washer



MLED Shapes



Lanova Catenary



DINING HALLS

Recommended Lighting

Direct/Indirect Lighting

Creates a balanced and versatile space

Warm Tones

Enhances social interactions, fostering a sense of community among students

Informal Ambiance

Provides a necessary break from classrooms

Glare Control

Contributes to a pleasant environment

Wall Washing / Wall Grazing

Draws attention to specific areas and directs student flow



ELO



Inula



Saturn



Melli™



PATHWAYS

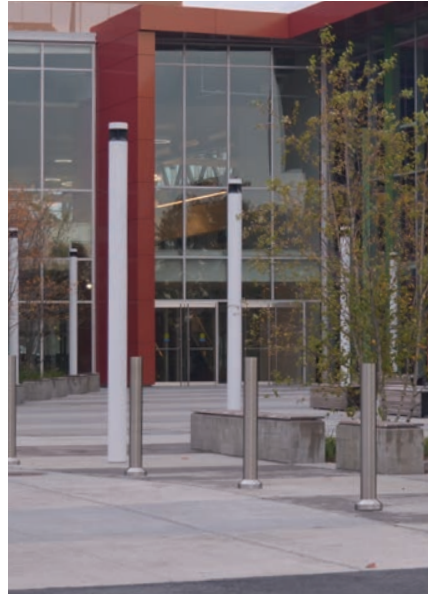

Recommended Lighting

Safety and Security

Proper lighting ensures that facial features are clearly defined

Uniform Illumination

Makes it easier for students to navigate at night

Reduced Glare

Improves comfort and ability to navigate

DarkSky

Reduces disruptive blue light emissions and minimizes light pollution, promoting better visibility for students

Sensors/Emergency Lighting

Deters crime, lowers maintenance costs, and reduces maintenance costs



Arca Pro



Ouray®



Discera



Ritorno



PARKING & ROADWAY



Recommended Lighting

Safety and Security

Illumination for teachers and students walking to their cars and transport

Maximum Spacing

Reduced dark spots for improved visibility and a feeling of security

Smart Lighting

Customized for specific areas of the campus

DarkSky

Shines light only where it is needed and minimizes light pollution

Glare Reduction

Improves driver visibility, reducing the chance of accidents



SPORTS AND RECREATION

M125



MTR Column



Olivio



Peeta™



Recommended Lighting

Safety and Visibility

Improves performance and reduces injury for athletes, spectators, and officials

IP Rated

Durable and weather-resistant regardless of the location

IK Rated

Robust design for facilities needing a high level of protection

Glare Control

Enhances the player and spectator experience

Smart Controls

Creates optimal conditions for various sports



COURTYARDS & GATHERING AREAS

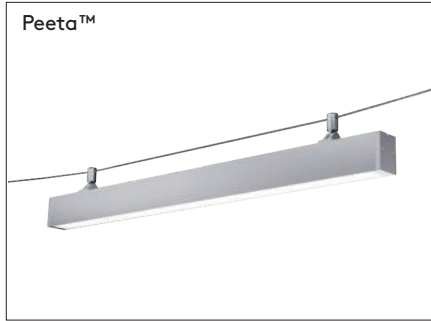

Recommended Lighting
Energy Efficient Improves safety, enhances campus environment, and reduces cost
Targeted Lighting Improves visibility and supports navigation
Warm Tones Creates a sense of comfort and relaxing atmosphere
Catenary Allows flexibility in arrangement, creating a safe and functional space for students and faculty









Publisher

Selux Corporation
5 Lumen Lane
Highland, NY 12528
www.selux.us

Edited by (responsible)

Selux Corporation

Concept and Design

Selux Corporation
www.selux.us

Print

Selux Corporation
5 Lumen Lane
Highland, NY 12528

Selux is a registered trademark of the Selux Corporation.
Errors accepted and subject to change due
to technical modifications. For conditions of sale
and delivery please refer to www.selux.us.

The use of the text and images, even in part, is
in breach of copyright without the consent of
the Selux Corporation and punishable. This also applies to
copies, translations, microfilming and processing
with electronic systems.

06/2026

