

MTR Bollards

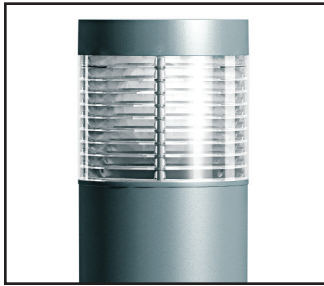

Project: _____

Type: _____ **Qty:** _____

_____ - _____ - _____ - _____ - _____ - _____
 Series Height Lamping Finish Voltage Options

Series		Height	Lamping			Finish	Voltage	Options									
BRMF	MTR Bollard Round Flat Top	2 2' (.6m)	<u>Metal Halide</u>			WH White	120	HS House Side Shield (180°)									
WRMF	MTR Wall Mount Round Flat Top	3 3' (.9m)	H050¹	50w	S050¹	50w	F32²	32w	BK Black	208	BZ Bronze	240	SV Silver	277	SP Specify Premium Color	347	REC GFCI Receptacle weather-proof cover
		4 4' (1.2m) or specify custom height Wall Mounting see p. 2	H070	70w	S070	70w	F42²	42w									
¹ Only available in 120v and 277v ² Not available in 208v or 240v																	

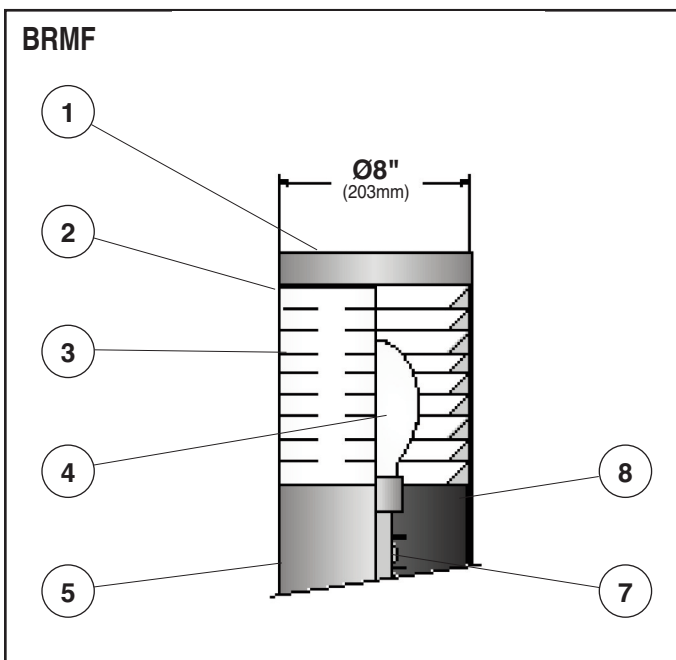

1. Fixture Cover - Die-cast aluminum cover, with flat round form to reflect and complement the column design. Thick walled, aluminum cover is painted white on the interior for maximum luminaire efficiency. Removes by loosening three, vandal-resistant, stainless steel screws for easy access to lamp chamber.

2. Gasketing - Continuous gaskets provide weather-proofing, dust, and insect control at shielding base, fixture cover and between MTR rings.

3. Shielding - Injection-molded acrylic multi-prisms for total reflection (MTR). MTR rings have a wall thickness of 0.591" (15mm) and are patterned after

the light bending characteristics of a prism. Secured to die-cast aluminum fitter.

4. Lamp - Enclosed by borosilicate glass cylinder. One coated, base down, medium base ED-17 metal halide up to 70w; high pressure sodium up to 70w; or triple tube, four pin GX24q-3 for 32w and GX24q-4 for 42w compact fluorescent. Lamp provided by others.

5. Column - Extruded, thick-walled aluminum, minimum wall thickness 0.118" (3mm). Available in a smooth round design, with three vertical grooves. Mounted to cast aluminum base with three, vandal-resistant, stainless steel counter-sunk screws.

6. Borosilicate Glass Cylinder - (Not shown) Provides thermal stability and filters U.V. rays from lamp. Secured by three retaining clips.

7. Ballast - Open core and coil ballast pre-wired to pulse rated, porcelain, medium base socket for HID lamps. Cold weather electronic ballast for fluorescent lamps. Consult factory for more detailed ballast information.

8. Column Fitter - Die-cast, aluminum fitter holds ballast assembly and lamp socket. Fastened

to column with three, vandal-resistant stainless steel, counter-sunk screws. Column fitter removal allows access to ballast assembly.

Exterior Luminaire Finish - Selux utilizes a high quality Polyester Powder Coating. All Selux luminaires and poles are finished in our Tiger Drylac certified facility and undergo a five stage intensive pretreatment process where product is thoroughly cleaned, phosphated and sealed. Selux powder coated products provide excellent salt and humidity resistance as well as ultra violet resistance for color retention. All products are tested in accordance with test specifications for coatings from ASTM and PCI.

Standard exterior colors are White (WH), Black (BK), Bronze (BZ), and Silver (SV). Selux premium colors (SP) are available, please specify from your Selux color selection guide.

Photometry

MTR Round Bollard / 70W Metal Halide

Catalog # **BRMF-H070**
Report # **ITL40308**

- Innovative “multi-prisms for total reflection” incorporates light-bending characteristics of a prism.
- Directs light precisely with minimum intensity at critical viewing angles.
- Blends efficiency with visual comfort.
- Maximum candela of 385 at 60° from vertical.

DOWNLOAD IES FILE:

http://www.selux.us/fileadmin/us/exterior/ies_file/BRM-BTM_IES.zip

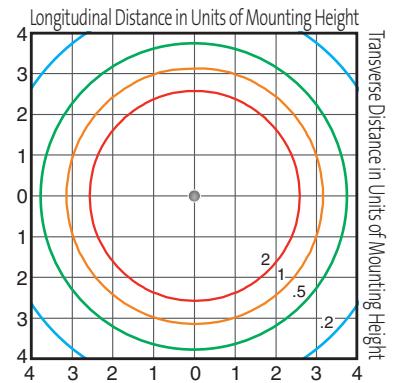
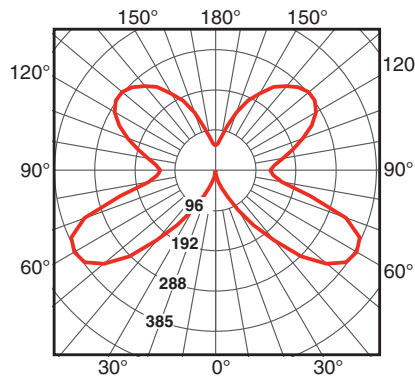

Lamp Prorate Table								
High Pressure Sodium			Metal Halide			Fluorescent		
Wattage	Factor	Initial Lumens	Wattage	Factor	Initial Lumens	Wattage	Factor	Initial Lumens
50	0.47	3700	50	0.44	3400	32	0.48	2400
70	0.74	5800	70	0.64	5000	42	0.64	3200

Conversion Chart	
Values based on 3' (.9m) mounting height	
Mounting Height	Multiply
2.0' (.6m)	2.25
2.5' (.8m)	1.44
3.0' (.9m)	1.00
3.5' (1.1m)	0.73
4.0' (1.2m)	0.56

Wall Mount Information

Die cast aluminum wall mount arm with die-cast aluminum canopy. Attaches to cast base of fixture. Secured to wall with 1/4" (6mm) diameter threaded fasteners (by others).

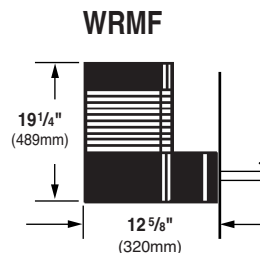

Wall Arm Mounting Detail

(Conduit and mounting hardware by others.)

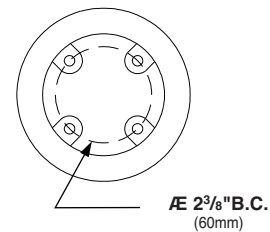

Anchorage Information

3. ADEQUATE DRAINAGE MUST BE PROVIDED IN CONCRETE FOUNDATION.
4. CONDUIT SHOULD BE STUBBED UP ABOVE THE CONCRETE FOOTING.

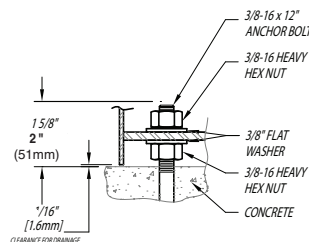
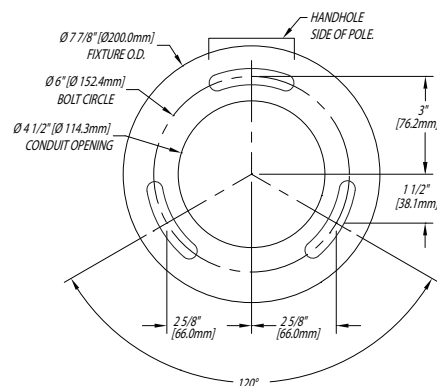

BOLT CIRCLE DETAIL (NOT TO SCALE)

USE CAUTION WHEN SETTING ANCHOR BOLTS. BOLTS MUST BE VERTICALLY STRAIGHT AND CENTERED ON DIMENSIONS SHOWN.

Profiles

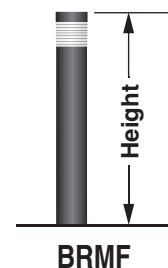

Option Details

GFCI Receptacle (REC) - 120V 15A GFCI duplex receptacle with weather-proof, self-closing cover; located 18" (457mm) from base of pole, inline with handhole. Receptacle is intended only for portable tools or other portable equipment to be connected to outlet only when attended by operating personnel. For use with 120V applications only. For other fixture voltages, please consult factory for wire segregation requirements.

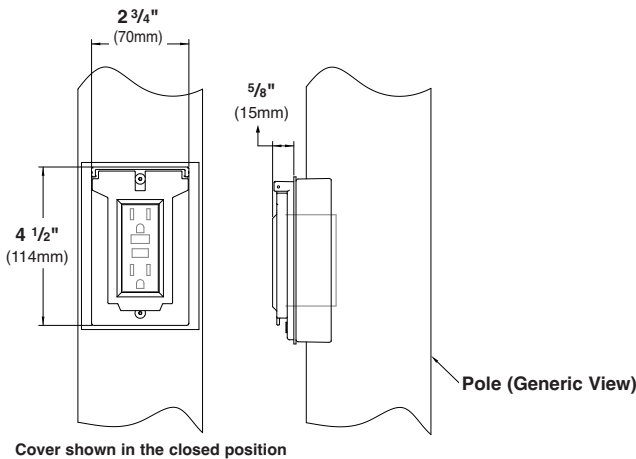

GFCI Receptacle (REC2) - 120V 15A GFCI duplex receptacle with weather-proof, self-closing, pad-lockable in-use cover; located 18" (457mm) from base of pole, inline with handhole. Receptacle is intended only for portable tools or other portable equipment to be connected to outlet only when attended by operating personnel. For use with 120V applications only. For other fixture voltages, please consult factory for wire segregation requirements.

