

Date: _____ Customer: _____

Project: _____

Type: _____ Qty: _____



M100 Shapes LED Direct

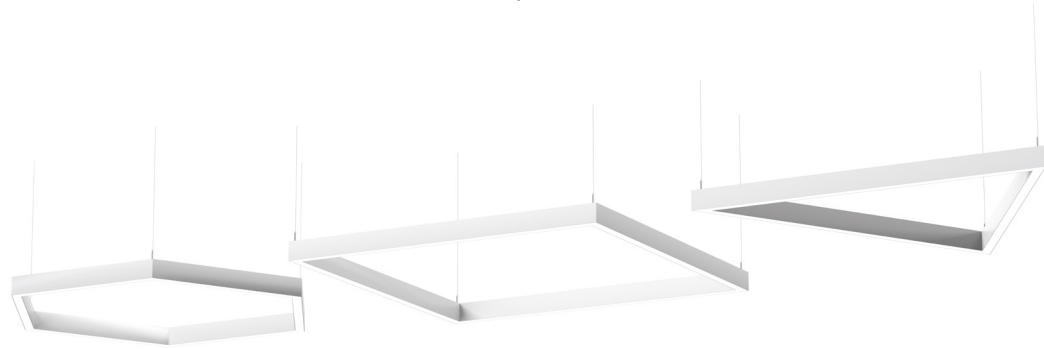

Order Code: L10 - - - - -

L10	Series	L10 Multi-Mount Form							
	Light Engine	1B45^{1,2} 789 lm/11.1W per foot	1B40^{1,2} 713 lm/9.8W per foot	1B35¹ 628 lm/8.6W per foot	1B30¹ 536 lm/7.2W per foot	1B25¹ 481 lm/6.4W per foot	1B20¹ 363 lm/4.7W per foot	¹ Values calculated from a 4' fixture at 4000K using LW shielding and a DIM driver. For additional information, please see page 2. ² Not available with Lutron	
	CCT	27 2700K 90+ CRI	30 3000K 90+ CRI	35 3500K 90+ CRI	40 4000K 90+ CRI				
	Shielding	LW LED Optimized White Lens	MI Clear Lens with Microprism						
	Mounting	C³ Cable	S³ Swivel Stem	RS³ Rigid Stem	F³ Surface Mount			³ 1' triangle, square and hexagon, along with 2' triangle and square are supplied as one housing. All other sizes and shapes are supplied in multiple housings joined together in the field.	
	Shape and Nominal Length	TX Triangle	QXY Rectangle/ Square	HX Hexagon	*X = 1', 2', 3', 4' *Y = 1', 2', 3', 4'			* Select shape and add nominal side length. For rectangles, indicate length and width. Example: Use T4 for a Triangle with sides 4' long. * For other lengths, shapes or configurations, please consult factory.	
	Finish	WH* White	BL* Semi-Matte Black	SV* Silver	SP* Specify Premium Color		* Custom colors are available, please consult factory		
	Voltage	120 120 Volt	277 277 Volt	UNV 120 through 277 50/60hz capable	347 347 Volt (consult factory)				
	Driver	DIM⁴ 0-10V (Linear)	DM^{4,5} eldoLED SOLoDrive 0-10V (Linear)	DML^{4,5} eldoLED SOLoDrive 0-10V (Logarithmic)	DMD^{4,5} eldoLED DALI (Logarithmic)	DC2^{4,5,6} Lutron 2-Wire	DE1^{4,5} Lutron EcoSystem	DC5 Lutron 5-Series (consult factory)	⁴ See page 6 for details ⁵ Not available in 1' side length ⁶ 120V only
	Fixture Options	DL Damp Location Rated	FS In-line Fuse						
	Emergency Options	EC Emergency Circuit Wiring (consult factory)	EMR Remote Micro Inverter (consult factory)						



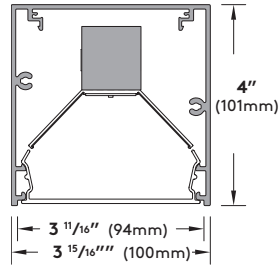

LW lens shown for reference

Construction:

Housing - Continuous, low copper 6063-T6 extruded aluminum profile available as Triangle, Square, Rectangle or Hexagon.

Geartray - Low copper 6063-T6 extruded aluminum profile.

Shielding - Extruded, impact resistant acrylic lens:
- LED Optimized White Lens (LW)
- Clear Lens with Microprism Inlay (MI)

Mounting(s) - 1/8" Aircraft Cable, Ø5/8" Swivel or Rigid Steel Stem, Wall Bracket, Surface mounting (see pages 3 through 6 for details).

Standard Luminaire lengths - All standard luminaires are supplied in nominal lengths to ensure full, even, illumination.

** Individual luminaires are not joinable in the field.

Exact length luminaires - Sizes and shapes other than those indicated are available to meet your project needs. Please consult factory with your requirements.

** Lens luminance may soften at the corners for exact length luminaires.

L10 Joiner(s) - 1' triangle, square and hexagon along with 2' triangle and square supplied as one housing. All other sizes, shapes and configurations are supplied in multiple housings joined together in the field using the supplied L10 joiner system. This allows ease of installation and ensures a uniform appearance (see page 8 for detail).

Weight: 3.2 lb. per foot.

Electrical/Performance:

LED Light Engine - Brand-name mid-power LEDs create a high efficiency LED light engine able to provide a lumen maintenance of 96% at 25,000 hours and 93% at 60,000 hours at 25°C per TM-21 reports. Reported L70 greater than 60,000 hours.

Delivered Lumens - Due to LED manufacturer's tolerances the listed output has a ±5% tolerance. For outputs based on different shielding or CCT please see photometry section at the end.

CCT - Available in 2700K, 3000K, 3500K and 4000K, tolerance within a 3-step MacAdam ellipse.

CRI - 90+.

All Drivers - High efficiency, constant current, soft start, Electronic Class 2 with a PFC>0.90. For more detailed information on the available drivers please see page 6.

Thermal Performance:

Ambient Operating Temperature - Luminaires suitable for maximum ambient temperature of

35°C (95°F) for all drivers.

Luminaires are suitable for minimum ambient temperatures of:

-40°C (-40°F) for DIM, DM, DML, and DMD drivers.

0°C (32°F) for DC2 and DE1 drivers.

Luminaire Finish:

Powder Coat - All Selux luminaires are finished in high quality polyester powder coating in our Tiger Drylac certified facility and are tested in accordance with test specifications for coatings from ASTM and PCI.

All products undergo a five stage intensive pretreatment process where product is thoroughly cleaned, phosphated, and sealed. Selux powder coated products provide excellent salt and humidity resistance as well as ultra violet resistance for color retention.

Standard interior colors are White (WH), Semi-Matte Black (BL), and Silver (SV). Selux premium colors (SP) are available, please specify from your Selux color selection guide.

Warranty:

5 Year Limited LED Luminaire Warranty -

Selux offers a 5 Year Limited Warranty to the original purchaser that the M100 series LED luminaire shall be free from defects in material and workmanship for up to five (5) years from date of shipment. This limited warranty covers the LED driver and LED light engine when installed according to Selux instructions and operated within the Ambient Temperature. For additional details and exclusions, see "Selux Terms and Condition of Sale."

Certifications and Compliance:

NRTL - For Dry and Damp location
(I.E. cULus)

ARRA Compliant

RoHS Compliant

Cable Mounting (C)

Housing Sections and Lens Lengths:

For standard shapes and sizes, lens lengths will always be equal to side lengths of the shape. Listed below are the nominal lengths and details for standard shapes. These standard shapes are standalone and cannot be combined with any other shapes or lengths. For non-standard sizes, shapes or configurations and patterns please consult factory.

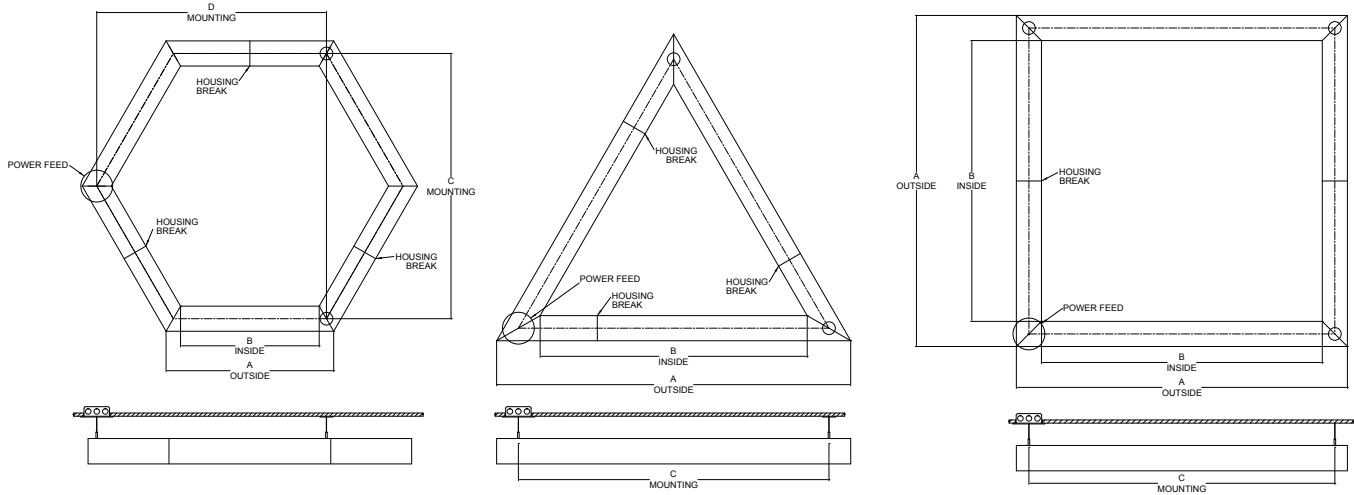

Shape	Hexagon								Triangle						Square					
	A Outside		B Inside		C Mounting		D Mounting		A Outside		B Inside		C Mounting		A Outside		B Inside		C Mounting	
Nominal Size	Feet/Inch	MM	Feet/Inch	MM	Feet/Inch	MM	Feet/Inch	MM	Feet/Inch	MM	Feet/Inch	MM	Feet/Inch	MM	Feet/Inch	MM	Feet/Inch	MM	Feet/Inch	MM
1X1	1' - 2 1/16"	367	0' - 9 1/16"	251	1' - 9"	533	1' - 6 3/16"	462	1' - 7 13/16"	503	0' - 6 3/16"	157	1' - 1"	330	1' - 4 3/16"	411	0' - 8 3/16"	211	1' - 1/4"	311
2X2	2' - 2 3/16"	670	1' - 9 13/16"	554	3' - 5 13/16"	1058	3' - 1/8"	918	2' - 7 3/16"	806	1' - 6 1/16"	460	2' - 1 13/16"	633	2' - 4 1/8"	714	1' - 8 1/16"	514	2' - 3/16"	614
3X3	3' - 2 3/16"	973	3' - 1 13/16"	949	5' - 2 3/16"	1584	4' - 6"	1372	3' - 7 11/16"	1110	2' - 6 1/16"	764	3' - 1/4"	937	3' - 4 1/16"	1018	2' - 8 3/16"	818	3' - 1/4"	918
4X4	4' - 2 1/4"	1276	3' - 9 11/16"	1160	6' - 11 1/16"	2109	5' - 11 13/16"	1827	4' - 7 3/16"	1413	3' - 6"	1067	4' - 1 13/16"	1240	4' - 4"	1321	3' - 8 1/16"	1121	4' - 1/16"	1221

*Dimension(s) rounded to the nearest 1/16" with a ± 1/16" (1mm) tolerance.

*For rectangle length and width dimensions, reference the square nominal size rows needed.

Note: lens length does not always match housing length. For standard lengths up to 4', lens will equal side length.

L10 Cable (C) Suspension Detail
(Feed location(s) only)

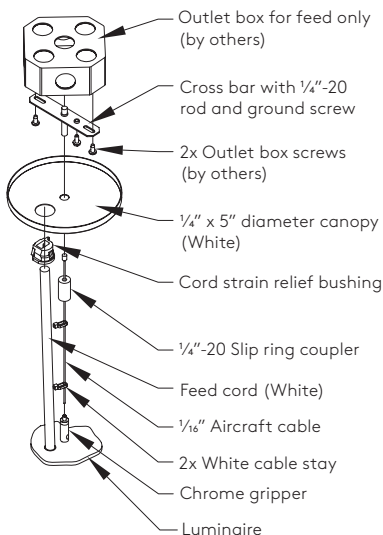

L10 Cable (C) Suspension Detail
(Non-Feed location(s) only)

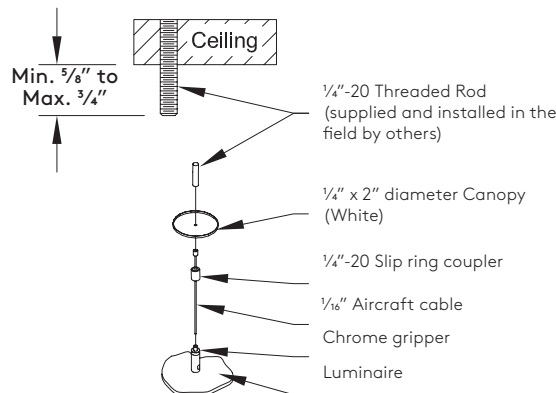

Cable Mounting (C)

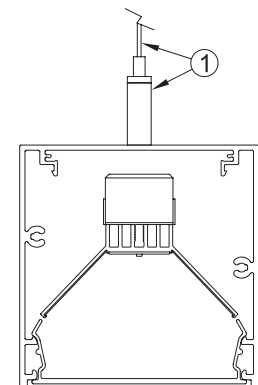

1. Ø1/16" Aircraft Cable with chrome gripper for easy adjustment (48" max. from ceiling to luminaire).

Stem Mounting (S and RS)

Housing Sections and Lens Lengths:

For standard shapes and sizes, lens lengths will always be equal to side lengths of the shape. Listed below are the nominal lengths and details for standard shapes. These standard shapes are standalone and cannot be combined with any other shapes or lengths. For non-standard sizes, shapes or configurations and patterns please consult factory.

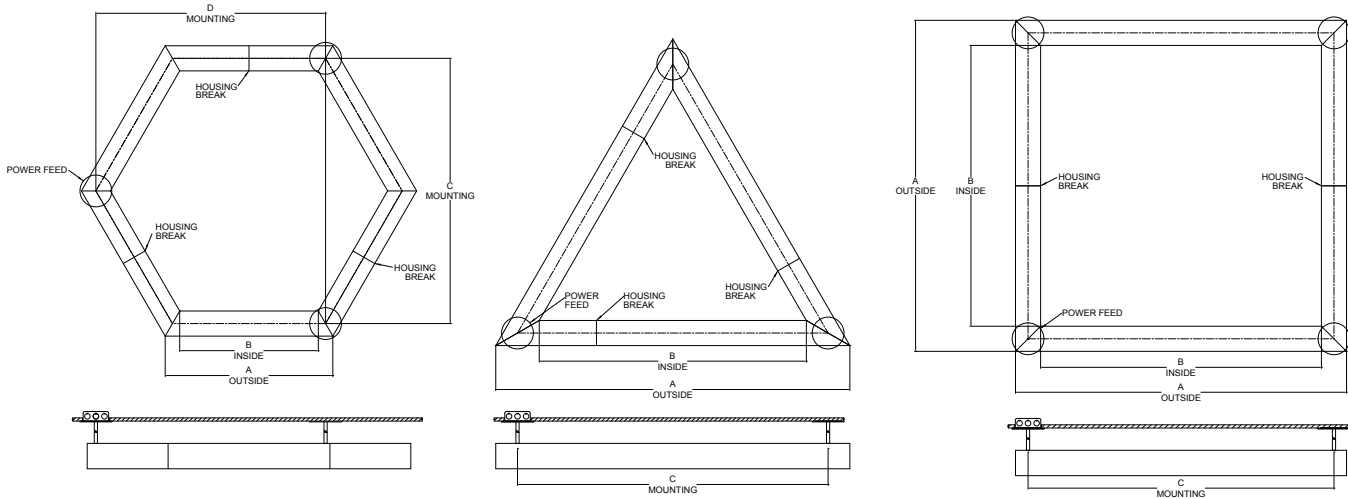

Shape	Hexagon								Triangle						Square					
	A Outside		B Inside		C Mounting		D Mounting		A Outside		B Inside		C Mounting		A Outside		B Inside		C Mounting	
Nominal Size	Feet/Inch	MM	Feet/Inch	MM	Feet/Inch	MM	Feet/Inch	MM	Feet/Inch	MM	Feet/Inch	MM	Feet/Inch	MM	Feet/Inch	MM	Feet/Inch	MM	Feet/Inch	MM
1X1	1' - 2 ¹ / ₁₆ "	367	0' - 9 ¹ / ₁₆ "	251	1' - 9"	533	1' - 6 ³ / ₁₆ "	462	1' - 7 ¹³ / ₁₆ "	503	0' - 6 ³ / ₁₆ "	157	1' - 1"	330	1' - 4 ³ / ₁₆ "	411	0' - 8 ³ / ₁₆ "	211	1' - 1/4"	311
2X2	2' - 2 ³ / ₁₆ "	670	1' - 9 ¹³ / ₁₆ "	554	3' - 5 ¹¹ / ₁₆ "	1058	3' - 1/8"	918	2' - 7 ³ / ₁₆ "	806	1' - 6 ¹ / ₁₆ "	460	2' - 1 ⁹ / ₁₆ "	633	2' - 4 ¹ / ₁₆ "	714	1' - 8 ¹ / ₁₆ "	514	2' - 3/16"	614
3X3	3' - 2 ³ / ₁₆ "	973	3' - 1 ³ / ₁₆ "	949	5' - 2 ³ / ₁₆ "	1584	4' - 6"	1372	3' - 7 ¹¹ / ₁₆ "	1110	2' - 6 ¹ / ₁₆ "	764	3' - 1/8"	937	3' - 4 ¹ / ₁₆ "	1018	2' - 8 ³ / ₁₆ "	818	3' - 1/8"	918
4X4	4' - 2 ¹ / ₁₆ "	1276	3' - 9 ¹¹ / ₁₆ "	1160	6' - 11 ¹¹ / ₁₆ "	2109	5' - 11 ¹⁵ / ₁₆ "	1827	4' - 7 ³ / ₁₆ "	1413	3' - 6"	1067	4' - 1 ⁹ / ₁₆ "	1240	4' - 4"	1321	3' - 8 ¹ / ₁₆ "	1121	4' - 1/16"	1221

*Dimension(s) rounded to the nearest 1/16" with a ± 1/16" (1mm) tolerance.

*For rectangle length and width dimensions, reference the square nominal size rows needed.

Note: lens length does not always match housing length. For standard lengths up to 4', lens will equal side length.

L1DI Swivel Stem (S) Suspension Detail
(feed wires through stem supplied by others)

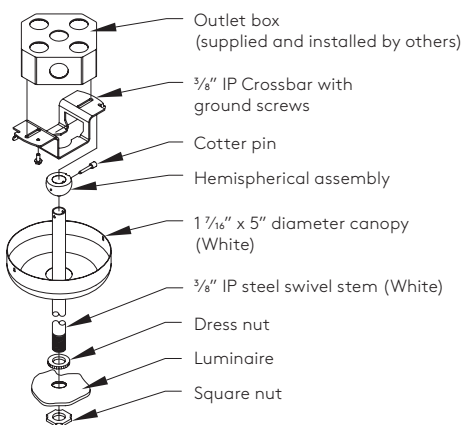

L1DI Rigid Stem (RS) Suspension Detail
(feed wires through stem supplied by others)

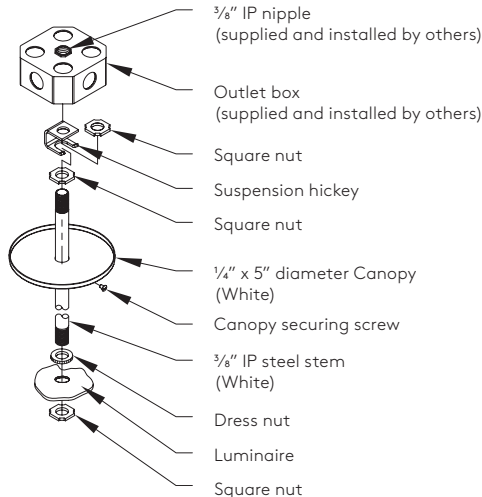

Stem Mounting (S and RS)

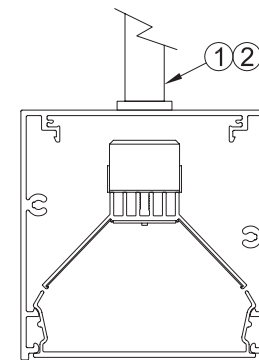

1. Ø3/8" Swivel Stem provides 30° swivel and **can be cut in field** (48" max. from ceiling to luminaire).
2. Ø3/8" Rigid Stem is fixed and is **not able to be cut/adjusted in field** (48" max. from ceiling to luminaire).

Surface Mounting (F)

For standard shapes and sizes, lens lengths will always be equal to side lengths of the shape. Listed below are the nominal lengths and details for standard shapes. These standard shapes are standalone and cannot be combined with any other shapes or lengths. For non-standard sizes, shapes or configurations and patterns please consult factory.

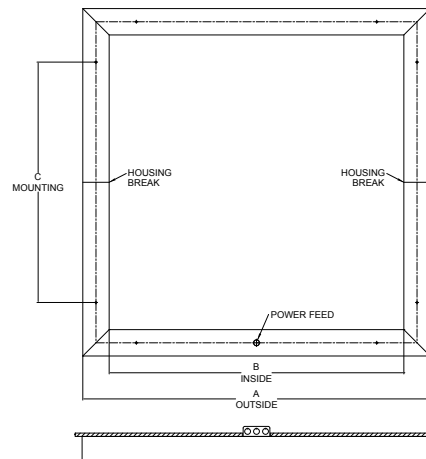
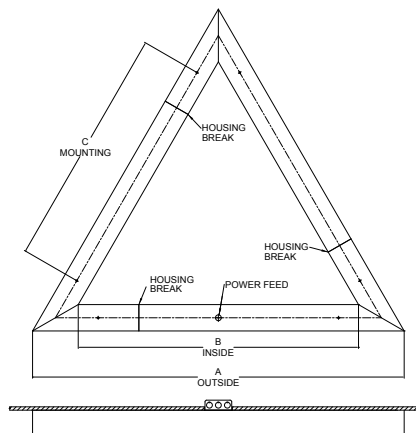
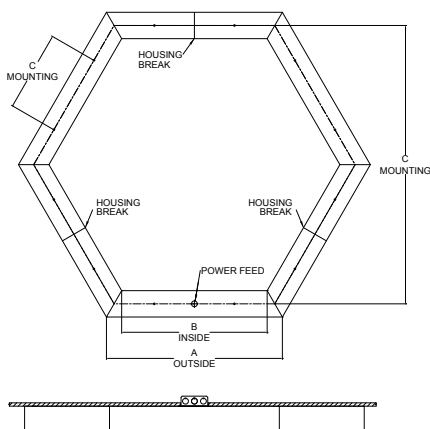

Shape	Hexagon						Triangle						Square					
	A Outside		B Inside		C Mounting		A Outside		B Inside		C Mounting		A Outside		B Inside		C Mounting	
Nominal Size	Feet/Inch	MM	Feet/Inch	MM	Feet/Inch	MM	Feet/Inch	MM	Feet/Inch	MM	Feet/Inch	MM	Feet/Inch	MM	Feet/Inch	MM	Feet/Inch	MM
1X1	1' - 2 ¹ / ₁₆ "	367	0' - 9 ¹ / ₁₆ "	251	0' - 6 ¹ / ₁₆ "	154	1' - 7 ¹³ / ₁₆ "	503	0' - 6 ³ / ₁₆ "	157	0' - 6 ¹ / ₂ "	165	1' - 4 ³ / ₁₆ "	411	0' - 8 ⁵ / ₁₆ "	211	0' - 8 ¹ / ₁₆ "	156
2X2	2' - 2 ³ / ₈ "	670	1' - 9 ¹³ / ₁₆ "	554	0' - 11 ¹³ / ₁₆ "	300	2' - 7 ³ / ₄ "	806	1' - 6 ¹ / ₈ "	460	1' - 1 ¹ / ₁₆ "	322	2' - 4 ¹ / ₈ "	714	1' - 8 ¹ / ₄ "	514	0' - 11 ¹⁵ / ₁₆ "	303
3X3	3' - 2 ¹ / ₁₆ "	973	3' - 1 ¹ / ₈ "	949	1' - 11 ¹ / ₄ "	603	3' - 7 ¹¹ / ₁₆ "	1110	2' - 6 ¹ / ₁₆ "	764	2' - 5 ¹ / ₈ "	651	3' - 4 ¹ / ₁₆ "	1018	2' - 8 ³ / ₁₆ "	818	1' - 11 ¹ / ₈ "	606
4X4	4' - 2 ¹ / ₄ "	1276	3' - 9 ¹¹ / ₁₆ "	1160	2' - 11 ¹¹ / ₁₆ "	906	4' - 7 ⁵ / ₈ "	1413	3' - 6"	1067	3' - 9 ¹ / ₁₆ "	929	4' - 4"	1321	3' - 8 ¹ / ₈ "	1121	2' - 11 ¹⁵ / ₁₆ "	910

*Dimension(s) rounded to the nearest 1/16" with a ± 1/16" (1mm) tolerance.
*For rectangle length and width dimensions, reference the square nominal size rows needed.

Note: lens length does not always match housing length. For standard lengths up to 4', lens will equal side length.

Surface Mount (F)

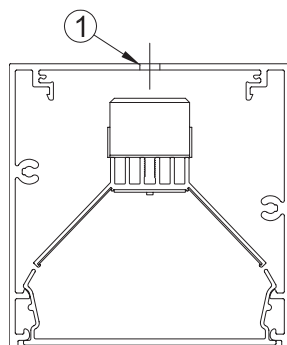

1. Ø³/₁₆" Mounting hole drilled at the factory (mounting hardware to code by others).

Drivers:

0-10V linear dimming (DIM)

Luminaires supplied with drivers offering the capability of either normal switched operation or 0-10V dimming for linear dimming curve. Fixtures ship wired for dimming. For on/off functionality, simply cap the dimming leads. Minimum dimming level preset at factory to 1%. (Due to size constraints, 1' side length luminaires are supplied with a driver from a different manufacturer than 2' and above luminaires. For details, please consult factory.)

eldoLED SOLOdrive 0-10V linear dimming (DM)

Luminaires supplied with SOLOdrive 0-10V dimming driver for linear dimming curve. Minimum dimming level preset at factory to 1%. For "dim to dark" (down to 0.1%), please consult factory.

eldoLED SOLOdrive 0-10V logarithmic dimming (DML)

Luminaires supplied with SOLOdrive 0-10V dimming driver for logarithmic dimming curve. Minimum dimming level preset at factory to 1%. For "dim to dark" (down to 0.1%), please consult factory.

LUTRON 2-wire dimming (DC2)

Luminaires supplied with Hi-Lume 2-wire dimming driver (120V only) programmed for Constant Current Reduction (CCR). For Pulse Width Modulation (PWM) dimming, please consult factory. Minimum dimming level down to 1%.

LUTRON Ecosystem dimming (DE1)

Luminaires supplied with Hi-Lume EcoSystem (4 wire, digital link) dimming driver programmed for Constant Current Reduction (CCR). For Pulse Width Modulation (PWM) dimming, please consult factory. Minimum dimming level down to 1% with SoftOn/FadeToBlack.

* For control recommendation, please contact driver manufacturer.

* For driver counts, see page 7.

Wiring Diagrams

0-10V linear (DIM)
0-10V linear eldoLED SOLOdrive (DM)
0-10V logarithmic eldoLED SOLOdrive (DML)
DALI eldoLED SOLOdrive (DMD)

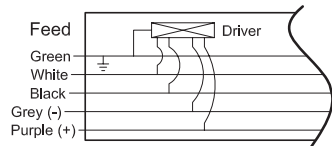

Lutron 2-Wire (DC2)

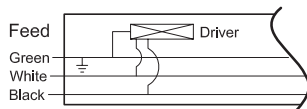

Standard Wiring supplied for all drivers.	Green = Ground White = Neutral Black = Hot
- The following wire(s) are in addition to the standard above -	
DIM, DM, DML & DMD	Gray = (-) DALI or 0-10V Dimming Control Purple = (+) DALI or 0-10V Dimming Control
DC2	No additional wires
DE1, DC5	Violet = "E1" Digital Link Dimming Control Violet/White = "E2" Digital Link Dimming Control

Lutron EcoSystem (DE1)
Lutron 5-Series (DC5)

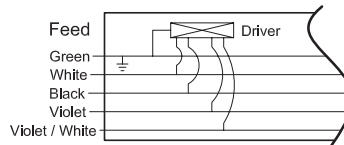

Driver Counts for DIM, DM, DMD, and DML drivers

Driver Type DIM, DM, DMD, DML	Driver Current		1B20	1B25	1B30	1B35	1B40	1B45
Pattern Shape	Pattern Size	Total Length	Driver Quantity					
	1'	4'	1*	1*	1*	1*	2*	2*
	2'	8'	1	1	2	2	2	2
	3'	12'	2	2	2	3	3	3
	4'	16'	2	2	4	4	4	4
	1'	3'	1*	1*	1*	1*	1*	1*
	2'	6'	1	1	1	2	2	2
	3'	9'	2	2	2	3	3	3
	4'	12'	2	2	2	3	3	3
	1'	6'	2*	2*	2*	2*	2*	2*
	2'	12'	2	2	2	3	3	3
	3'	18'	3	3	3	6	6	6
	4'	24'	3	3	6	6	6	6

* DIM option only

Driver Counts for DE1 drivers

Driver Type DE1	Driver Current		1B20	1B25	1B30	1B35	1B40	1B45
Pattern Shape	Pattern Size	Total Length	Driver Quantity					
	1'	4'	NA	NA	NA	NA	NA	NA
	2'	8'	2	2	2	2	2	2
	3'	12'	2	2	2	3	3	3
	4'	16'	4	4	4	4	4	4
	1'	3'	NA	NA	NA	NA	NA	NA
	2'	6'	1	1	1	3	3	3
	3'	9'	2	2	3	3	3	3
	4'	12'	2	2	2	3	3	3
	1'	6'	NA	NA	NA	NA	NA	NA
	2'	12'	2	2	2	3	3	3
	3'	18'	6	6	6	6	6	6
	4'	24'	6	6	6	6	6	6

Driver Counts for DC2 drivers

Driver Type DC2	Driver Current		1B20	1B25	1B30	1B35	1B40	1B45
Pattern Shape	Pattern Size	Total Length	Driver Quantity					
	1'	4'	NA	NA	NA	NA	NA	NA
	2'	8'	2	2	2	2	2	4
	3'	12'	2	3	3	3	3	4
	4'	16'	2	4	4	4	4	6
	1'	3'	NA	NA	NA	NA	NA	NA
	2'	6'	2	2	2	2	2	2
	3'	9'	3	3	3	3	3	3
	4'	12'	2	3	3	3	3	4
	1'	6'	NA	NA	NA	NA	NA	NA
	2'	12'	2	3	3	3	3	4
	3'	18'	3	6	6	6	6	6
	4'	24'	4	6	6	6	6	8

Fuse (FS) - Fusing, luminaires supplied with a in-line fuse located on the hot wire for each feed. (supplied with an 8A slow burn fuse).

Damp Location (DL) - Luminaires are suitable for use in damp location(s). Examples of such locations include protected areas under canopies, marquees, roofed porches, and similar locations where the fixture(s) are protected from direct contact with rain, snow, or excessive moisture (such as ocean spray). Interior locations include areas subject to moderate degrees of moisture, such as basements and certain barns and cold storage buildings. All solder points on LED boards are conformal coated. The phosphor layer of the LEDs is free of coating to avoid hazing.

Joiner System - standard for multi-piece housings

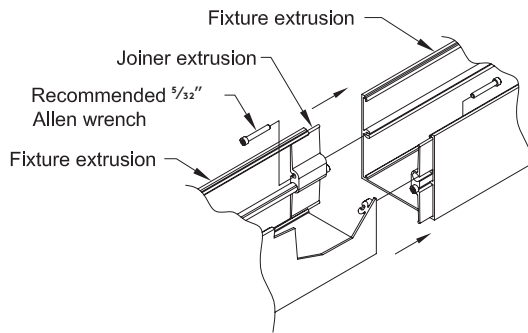

Housing Breaks and Lens Lengths

For standard shapes and sizes, lens lengths will always be equal to side lengths of the shape. These standard shapes are standalone and cannot be combined with any other shapes or lengths. For non-standard sizes, shapes or configurations and patterns please consult factory.

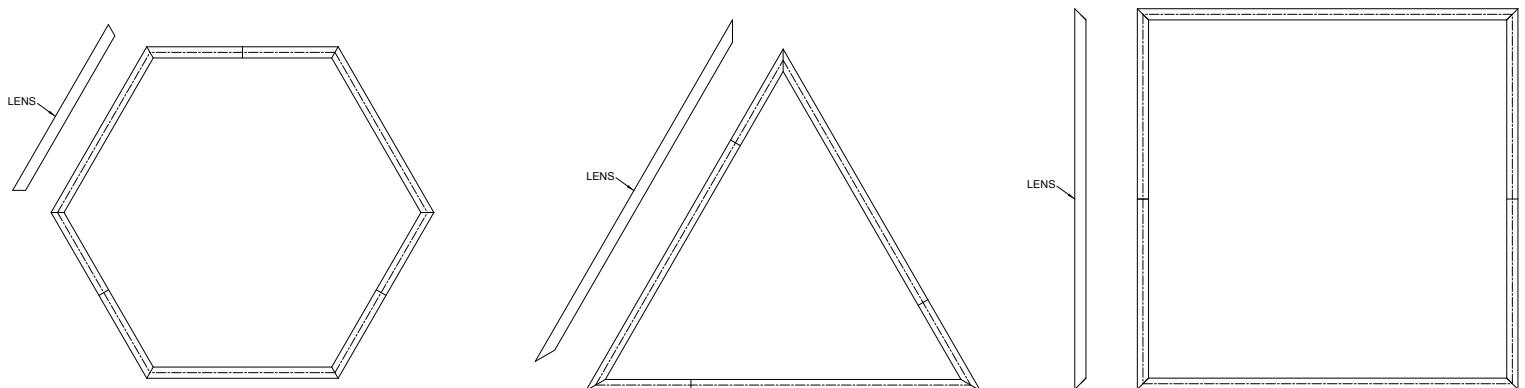

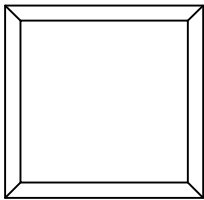
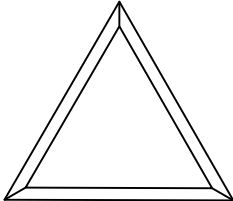
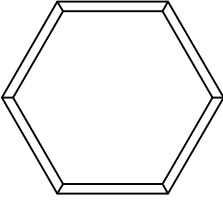
PATTERN SHAPE	PATTERN SIZE	TOTAL LENGTH	FIXTURE SERIES	DRIVER CURRENT					
				1B20	1B25	1B30	1B35	1B40	1B45
				TOTAL LUMENS*					
	1 FT	4 FT	L36	1668	2212	2468	2888	3284	3632
			L60	1452	1924	2144	2512	2852	3156
			L100	1632	2160	2412	2824	3208	3548
	2 FT	8 FT	L36	3336	4424	4936	5776	6568	7264
			L60	2904	3848	4288	5024	5704	6312
			L100	3264	4320	4824	5648	6416	7096
	3 FT	12 FT	L36	5004	6636	7404	8664	9852	10896
			L60	4356	5772	6432	7536	8556	9468
			L100	4896	6480	7236	8472	9624	10644
	4 FT	16 FT	L36	6672	8848	9872	11552	13136	14528
			L60	5808	7696	8576	10048	11408	12624
			L100	6528	8640	9648	11296	12832	14192
	1 FT	3 FT	L36	1251	1659	1851	2166	2463	2724
			L60	1089	1443	1608	1884	2139	2367
			L100	1224	1620	1809	2118	2406	2661
	2 FT	6 FT	L36	2502	3318	3702	4332	4926	5448
			L60	2178	2886	3216	3768	4278	4734
			L100	2448	3240	3618	4236	4812	5322
	3 FT	9 FT	L36	3753	4977	5553	6489	7389	8172
			L60	3267	4329	4824	5652	6417	7101
			L100	3672	4860	5427	6354	7218	7983
	4 FT	12 FT	L36	5004	6636	7404	8664	9852	10896
			L60	4356	5772	6432	7536	8556	9468
			L100	4896	6480	7236	8472	9624	10644
	1 FT	6 FT	L36	2502	3318	3702	4332	4926	5448
			L60	2178	2886	3216	3768	4278	4734
			L100	2448	3240	3618	4236	4812	5322
	2 FT	12 FT	L36	5004	6636	7404	8664	9852	10896
			L60	4356	5772	6432	7536	8556	9468
			L100	4896	6480	7236	8472	9624	10644
	3 FT	18 FT	L36	7506	9954	11106	12996	14778	16344
			L60	6534	8658	9648	11304	12834	14202
			L100	7344	9720	10854	12708	14436	15966
	4 FT	24 FT	L36	10008	13272	14808	17328	19704	21792
			L60	8712	11544	12864	15072	17112	18936
			L100	9792	12960	14472	16944	19248	21288

* All values based on 4000K CCT with LW Lens and DIM driver.

Photometry

LW Optics / 34W LED / 4000K CCT

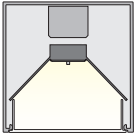

Catalog #: L10-1B35-40-LW-04-XX-UNV
Report #: 11685024.03
Delivered Lumens: 2822
Input Watts: 34W
Efficacy: 83
CCT: 4000K
CRI: 95.7

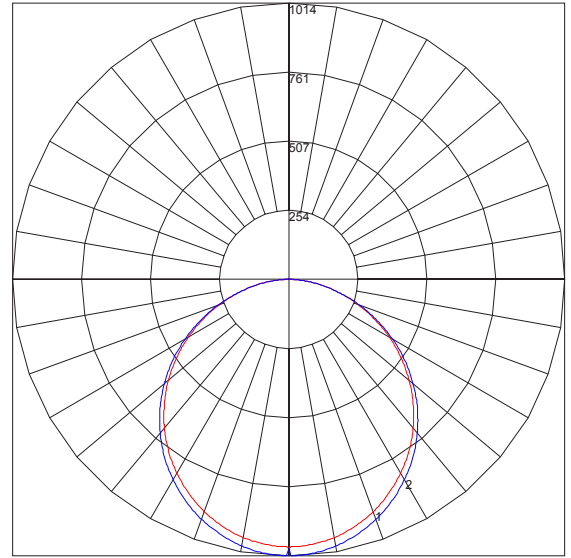

Maximum Candela = 1014 Located At Horizontal Angle = 0, Vertical Angle = -5
1 - Vertical Plane Through Horizontal Angles (90 - 270)
2 - Vertical Plane Through Horizontal Angles (0 - 180)

MI Optics / 34W LED / 4000K CCT

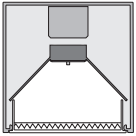

Catalog #: L10-1B35-40-MI-X-04-XX-UNV
Report #: 11685024.07
Delivered Lumens: 2963
Input Watts: 34W
Efficacy: 87
CCT: 3950K
CRI: 95.7

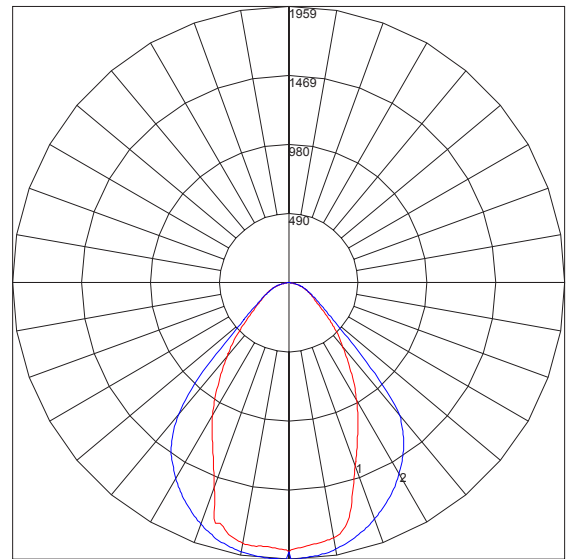

Maximum Candela = 1959 Located At Horizontal Angle = 0, Vertical Angle = 1
1 - Vertical Plane Through Horizontal Angles (90 - 270)
2 - Vertical Plane Through Horizontal Angles (0 - 180)

Photometry

L100 LED Photometry Multiplier Table		
CCT Multiplier		
4000K	1.000	
3500K	0.972	
3000K	0.963	
2700K	0.931	
Light Engine Multiplier		
Light Engine	Lumens	Wattages
1B45	1.258	1.285
1B40	1.137	1.140
1B35	1.000	1.000
1B30	0.855	0.838
1B25	0.766	0.740
1B20	0.578	0.552
Lens Multiplier		
LW	1.000	
MI	1.050	

CCT multipliers apply to the photometry, IES files, and per foot values listed on page one (light engine).

Light engine and lens multipliers supplied for per foot values listed on page one (light engine).