

Date: _____ Customer: _____

Project: _____

Type: _____ Qty: _____



Kju Configurations

Kju Circle or Square

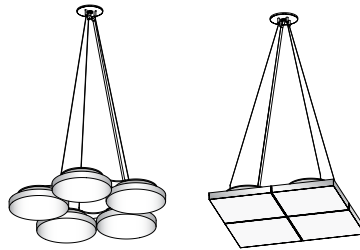

Order Code: KC - _____ - _____ - _____

Series **KC**
KJU Configuration

Form **Linear**

L2 L3 L4 Lx* **Number of fixtures in a straight line



Rectangular (Full)

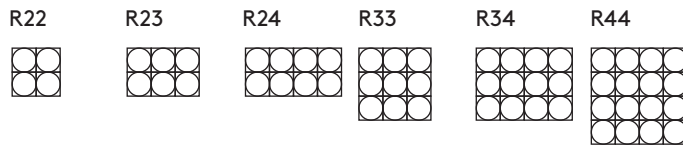

Rectangular (Open)

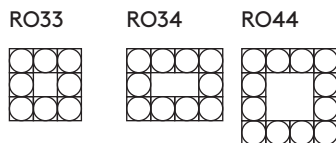

Circular

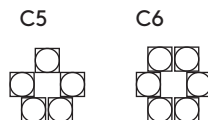

Freeform

Fx* **Number of fixtures in a configuration

Options **BC**
Optional Back Covers

Kju Ordering Code * See Kju Circle or Square spec sheets for fixture ordering code



KJU Square as reference

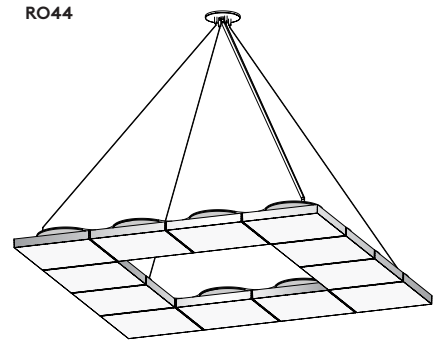
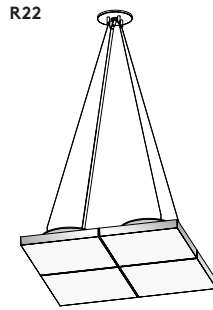
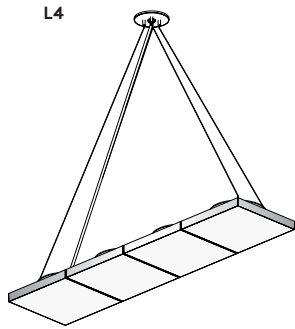
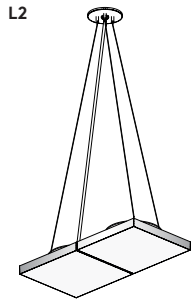

KJU Circle as reference

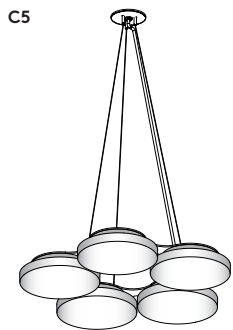

**Examples of Cable locations shown.
For additional information please
consult the factory.**