

# M100 Recessed Wall Washer Linear Fluorescent Flanged Extrusion

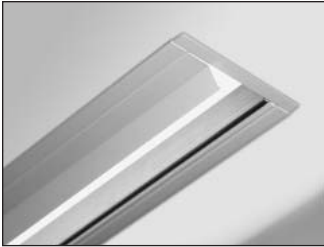

Project: \_\_\_\_\_ Type: \_\_\_\_\_ Qty: \_\_\_\_\_

Fixture Series    Lamp Type    Mounting    Mounting Option    Nominal Length    Finish    Voltage

Options (refer to separate data sheets for ordering codes and details)

Fixture Series	Lamp Type	Mounting	Nominal Length	Finish	Voltage	Options
<b>M1W1</b> M100 Wall Washer Continuous Flange (Flanged Extrusion/ Flanged Endcaps)	1T5 F28T5	SH Suspension Clips	004 4 foot	WH White	120	<b>TB</b> Lengths to Fit 2' Grid T-Bar Ceiling System <b>(qty.)EM</b> Stand-by Battery Pack <sup>1</sup> (prefix quantity, i.e. - 5EM) <b>FS</b> Single Fusing <b>DM</b> Dimming <sup>1</sup> (specify system) <b>DMA</b> Digital Addressable Dimming <sup>1</sup> <b>FW</b> Flex Whip (standard) <b>FW1</b> Flex Whip (dimming) <b>DL</b> Suitable for Damp Locations <b>CCEA</b> Chicago Plenum
	1T5HO F54T5HO	TS 1" Studs (factory installed)	008 8 foot	BK Black	277	
		RC Rotating Crossbars	012 12 foot	SV Silver	347	
<b>M1W2</b> M100 Wall Washer Flanged Extrusion/ Flush End (Flanged Extrusion/ Flangeless Endcaps)				SP Specify RAL#		

<sup>1</sup> Must be low profile ballasts (Consult factory for details.); consult factory for details.

## Mounting Diagrams

Scale = 1 : 8

Suspension Clips (SH)

Pre-installed Rod (TS)

Rotating Crossbars (RC)

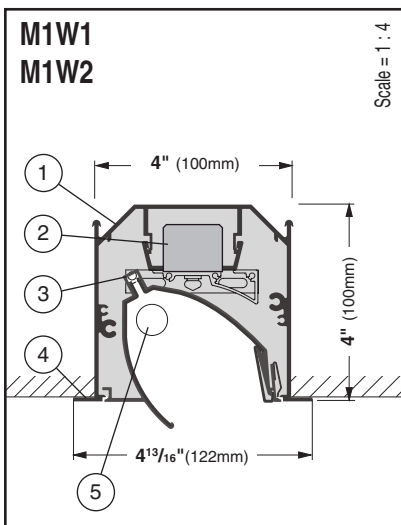
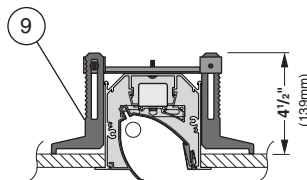
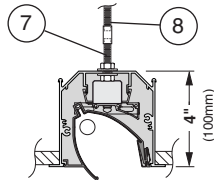
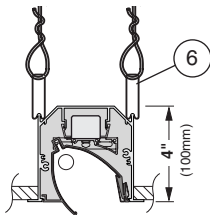

**1. Housing** - Continuous, 6063-T5 extruded aluminum profile up to 16 feet long. Joined with Connector Plus Joining System for ease of installation and to assure a uniform appearance.

**2. Ballast** - Electronic, high power factor, class "P", type "A" sound rating. Specify 120v, 277v, or 347v. Ballast is factory pre-wired with leads to one end of fixture. Consult factory for ballast options.

**3. Gear Tray** - Extruded aluminum, with white painted finish. Gear tray installed as a complete electrical unit and is held in place with knurled dress nuts. It is fully accessible from below ceiling.

**4. Flange** - 1/2" (12mm) wide flange runs full lengths of both sides and is part of the main extruded body. Specify continuous flange (M1W1) or flush end (M1W2).

**5. Lamps** - As noted (by others). Other lamp lengths or wattages available, consult factory.

**6. Spring Steel Suspension Clips** - Supplied two places, located nominally every 4 ft. Support wires supplied and installed by others.

**7. Pre-installed 1" 1/4-20 Stud** - Attached to fixture every nominal 4 feet.

**8. Coupling and Threaded Rod to Structure** - Supplied and installed by others.

**9. Rotating Crossbar** - For inaccessible ceilings, adjustable for ceiling thicknesses from 1/4" to 2". Support required nominally every 4'.

**Interior Luminaire Finish** - Standard interior colors are White (WH), Black (BK) and Silver (SV). RAL colors (SP) are available, please specify RAL#.

SELUX Corp. © 2006  
 TEL: (845) 691-7723  
 FAX: (845) 691-6749  
 www.selux.com/USA  
 M1W1-01 (v5.0)



Union Made Affiliated  
 with IBEW Local 363

In a continuing effort to offer the best product possible, we reserve the right to change, without notice, specifications or materials that in our opinion will not alter the function of the product. Specification sheets found at www.selux.com/usa are the most recent versions and supercede all other printed or electronic versions.

## M1W1 and M1W2 Layout Dimensions

Specify T5 lamps when using in grid ceiling systems where 24" or 48" light openings are required.

### M1W1 Recessed - nominal 4 foot individual



### M1W1 Recessed - T-Bar Length - nominal 4 foot individual

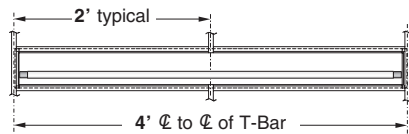

### M1W1 Recessed - nominal 8 foot individual

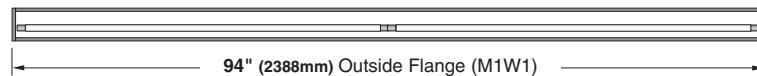

### M1W1 Recessed - T-Bar Length - nominal 8 foot individual

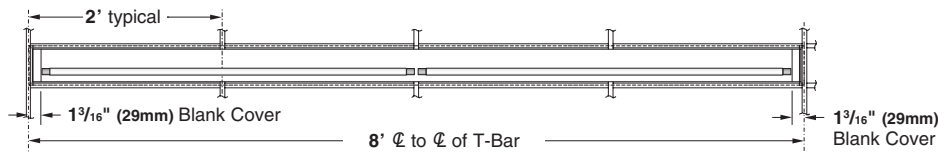

### M1W1 Recessed - nominal 12 foot individual

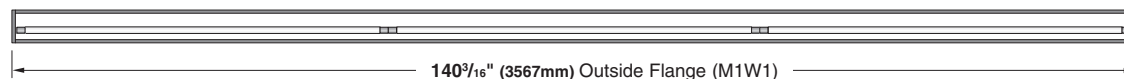

### M1W1 Recessed - T-Bar Length - nominal 12 foot individual

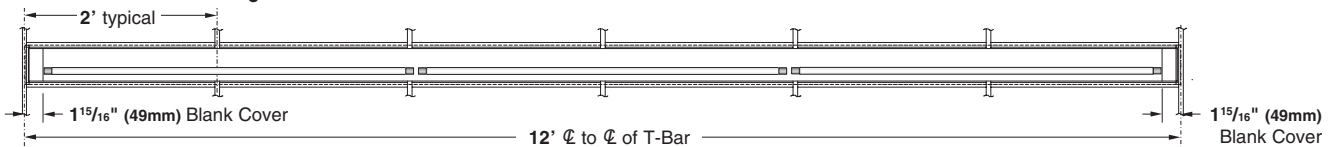

### Typical Side View (12 foot individual shown, other lengths similar)

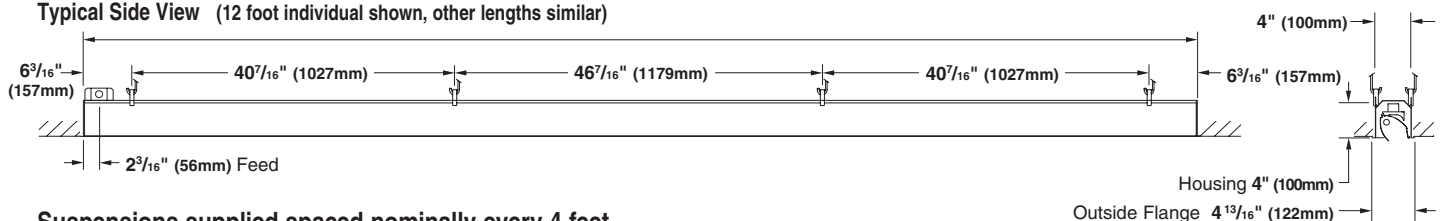

Suspensions supplied spaced nominally every 4 feet.

Fixture supplied with 7/8 knockout located 2 3/16" from end in top of fixture.

For other lengths, lamping, continuous runs or configurations please specify overall length (in feet), accessories desired and sketch/drawing of configuration. SELUX will detail project drawings upon order and supply submittal drawings for approval. Individual fixtures cannot be field joined. If you have any questions please contact SELUX customer service or applications engineering for assistance (1-800-SELUX-CS).

### Continuous Flange (M1x1)



(M1R1 Shown)



(M1R2 Shown)