

M100 Linear Fluorescent Direct Surface, Pendant & Wall

selux

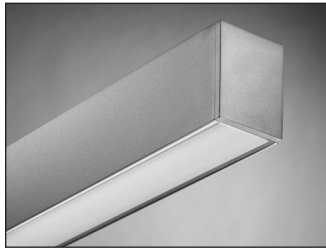

Project: _____ **Type:** _____ **Qty:** _____

| Fixture Series | Lamp Type | Shielding | Mounting | Nominal Length | Finish | Voltage |
|----------------|-----------|-----------|----------|----------------|--------|---------|
| M10 | | | | | | |

Options

| Fixture Series | Lamp Type | Shielding | Mounting | Nominal Length | Finish | Voltage | Options |
|--|----------------|-----------------------|------------------------|---|--------------------------|---------|---|
| M10 M100 Direct Multi-Mount Form | 1T5 F28T5 | SD Satine Lens | F Surface Mount | 004 4 foot | WH White | 120 | (qty)EM Stand-by Battery Pack ¹ (prefix quantity, i.e. - 5EM) DM Dimming ¹ (specify system) DMA Digital Addressable Dimming ¹ FS Single Fusing FW Flex Whip (standard) FW1 Flex Whip (dimming) Track Eutrac Standard ² DL Suitable for Damp Locations Downlights |
| | 2T5 (2x)F28/T5 | OD Extra Diffuse Lens | C Cable | 008 8 foot | BK Black | 277 | |
| | 1T5HO F54T5HO | X None | S Swivel Stem | 012 12 foot | SV Silver | 347 | |
| | 1T8 F032/T8 | | RS Rigid Stem | | SP Specify Premium Color | | |
| | | | W Wall Mount | For actual lengths see following page. For other lengths, configurations indicate nominal length rounded to the next highest foot. Factory will supply layout drawings. Individual fixtures cannot be field joined. | | | |
| | | | TE Telescoping Endcaps | | | | |

¹Must be low profile ballasts (1 1/2" W x 1 3/16" H); consult factory for details. ²Consult factory for details.

Mounting Diagrams

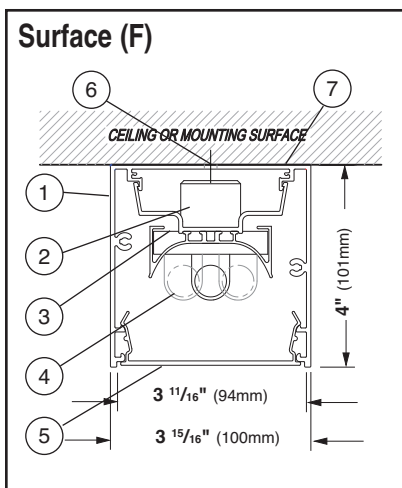
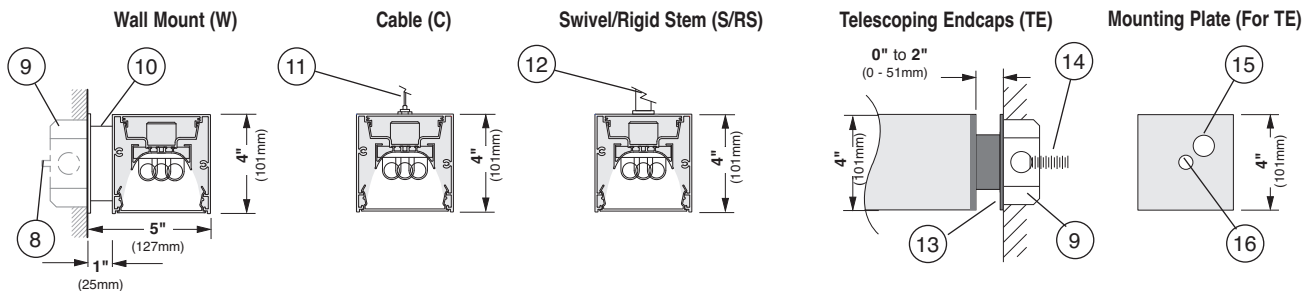

1. Housing - Continuous, 6063-T5 extruded aluminum profile up to 16 feet long. Joined with Connector Plus Joining System for ease of installation and to assure a uniform appearance.

2. Ballast - Electronic, high power factor, class "P," type "A" sound rating. Specify 120v, 277v, or 347v. Ballast is factory pre-wired with leads to one end of fixture. Consult factory for ballast options.

3. Gear Tray - Extruded aluminum, with white painted finish. Gear tray installed as a complete electrical unit and is held in place with knurled dress nuts. It is fully accessible from below ceiling.

4. Lamps - As noted (by others). Other lamp lengths or wattages available, consult factory.

5. Shielding - Extruded, impact resistant acrylic snap in lens: Extra diffuse (OD) or satine (SD).

6. Ø 7/8" Feed Hole - Drilled at factory 2 1/4" from end of fixture.

7. Ø 9/32" Mounting Holes (2) - Drilled at factory 6 1/4" from end of fixture and nominally every 24" Mounting hardware supplied and installed by others

8. Ø 1/4" Threaded Rod and Mounting Hardware - To anchor End Cap Support Bracket/Wall Bracket, supplied and installed by others.

9. Outlet Box - Supplied and installed by others.

10. Wall Bracket - 4" square aluminum wall bracket provided. See layout page- for details.

11. 1/16" Aircraft Cable Suspension - Supplied with chrome gripper for easy adjustment. 48" max suspension from ceiling to top of luminaire.

12. 5/8" Steel Swivel Stem or Rigid Stem Suspension - Swivel Stem provides 30° swivel rotation and can be cut in field; Rigid Stem can not be cut in field. 48" max suspension from ceiling to top of luminaire.

13. End Cap Support Brackets - Welded flush to end of fixture. Supplied with extruded aluminum cover profile. Two lock-down screws on bottom of fixture.

14. Ø 1/2" Threaded Rod - supplied and installed by others.

15. Ø 7/8" Feed Hole - In wall plate offset from center.

16. Ø 9/16" Mounting Hole - Centered in wall plate.

Interior Luminaire Finish - Standard interior colors are White (WH), Black (BK) and Silver (SV). Selux premium colors (SP) are available, please specify from your Selux color selection guide.

Selux Corp. © 2018
 TEL: (845) 834-1400
 FAX: (845) 834-1401
 www.selux.us
 M10-0118-01 (v6.1)



In a continuing effort to offer the best product possible, we reserve the right to change, without notice, specifications or materials that in our opinion will not alter the function of the product. Specification sheets found at www.selux.us are the most recent versions and supercede all other printed or electronic versions.

M10 Surface / Pendant / Wall Layout Dimensions

Specify T5 lamps when using in grid ceiling systems where 24" or 48" light openings are required.

Nominal 4 foot individual - Bottom view

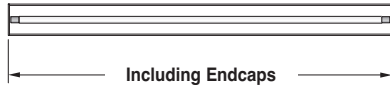

Nominal 8 foot individual - Bottom view

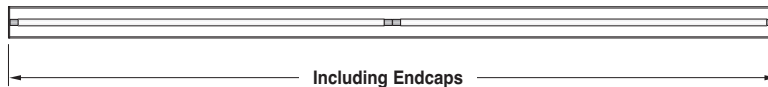

Nominal 12 foot individual - Bottom view

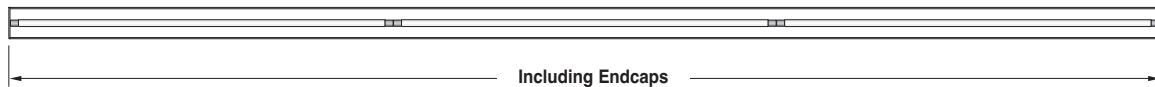

Typical Surface Mount Side View (Fixture supplied with 7/8 knockout located 2³/₁₆" from end in top of fixture.)

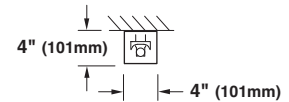
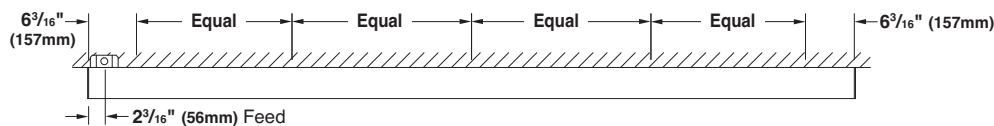

Typical Pendant Mount - Side View

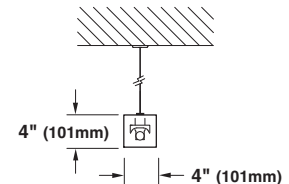
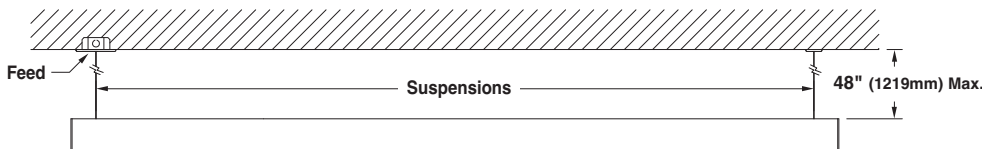

Typical Wall Mount - Top View

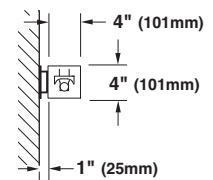
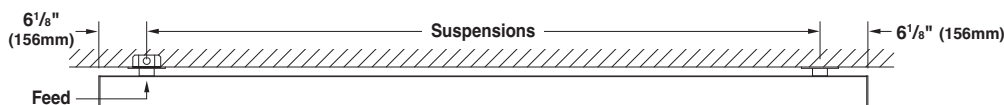

| | T5 (1 or 2 lamp) | | | T8 (1 lamp) | | |
|---------------------------|---------------------|---------------------|------------------|---------------------|---------------------|------------------|
| | Including Endplates | Pendant Suspensions | Wall Suspensions | Including Endplates | Pendant Suspensions | Wall Suspensions |
| 4 foot individual | 46.81" (1189mm) | 40.46" (1027mm) | 34.46" (875mm) | 48.37" (1229mm) | 42.08" (1069mm) | 36.08" (916mm) |
| 8 foot individual | 93.21" (2368mm) | 86.88" (2206mm) | 80.87" (2054mm) | 96.41" (2449mm) | 90.12" (2289mm) | 84.12" (2137mm) |
| 12 foot individual | 139.65 (3547mm) | 133.28" (3385mm) | 127.29" (3233mm) | 144.45" (3669mm) | 138.16" (3509mm) | 132.16" (3357mm) |

For other lengths, lamping, continuous runs or configurations please specify overall length (in feet), accessories desired and sketch/drawing of configuration. Selux will detail project drawings upon order and supply submittal drawings for approval. Individual fixtures cannot be field joined. If you have any questions please contact Selux customer service or applications engineering for assistance (1-800-SELUX-CS).