

# M100 Recessed Linear Fluorescent Asymmetrical Flanged Extrusion

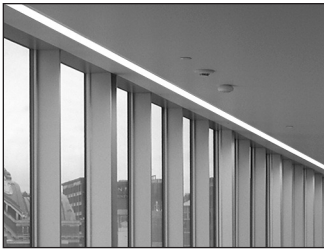

**Project:** \_\_\_\_\_ **Type:** \_\_\_\_\_ **Qty.** \_\_\_\_\_

Series	Lamping	Shielding	Mounting	Nominal Length	Finish	Voltage

**Options**

Series	Lamping	Shielding	Mounting	Nominal Length	Finish	Voltage	Options
<b>M1RA1</b> M100 Recessed Asymmetrical Continuous Flange (Flanged Extrusion/ Flanged Endcaps)  <b>M1RA2</b> M100 Recessed Asymmetrical Flush End (Flanged Extrusion/ Flangeless Endcaps)	<b>1T5</b> F28T5  <b>1T5HO</b> F54T5HO  <b>1T8</b> F32T8	<b>AMP</b> Asymmetric Silky Specular Louver  <b>SD</b> Satine Lens	<b>SH</b> Suspension Clips  <b>TS</b> 1" Studs (factory installed)  <b>RC*</b> Rotating Crossbars  <b>PM*</b> Perimeter Mount  (* = Not available with TB option.)	<b>004</b> 4 foot  <b>008</b> 8 foot  <b>012</b> 12 foot  For actual lengths see following page. For other lengths, configura- tions indicate nominal length rounded to the next highest foot. Factory will supply layout draw- ings. Individual fixtures cannot be field joined.	<b>WH</b> White  <b>BK</b> Black  <b>SV</b> Silver  <b>SP</b> Specify Premium Color	<b>120</b>  <b>277</b>  <b>347</b>	<b>TB</b> Lengths to Fit 2' Grid T-Bar Ceiling System <sup>1</sup>  <b>(qty)EM</b> Stand-by Battery Pack <sup>2</sup> (prefix quantity, i.e. - <b>5EM</b> )  <b>FS</b> Single Fusing  <b>DM</b> Dimming <sup>2</sup> (specify system)  <b>DMA</b> Digital Addressable Dimming <sup>2</sup>  <b>FW</b> Flex Whip (standard)  <b>FW1</b> Flex Whip (dimming)  <b>DL</b> Suitable for Damp Locations  <b>CCEA</b> Chicago Plenum  <b>SI</b> Satine Acrylic Inlay (for AMP only)
	<sup>1</sup> T5 & T5HO lamps only, consult factory for other lamps. <sup>2</sup> Must be low profile ballasts (1 1/2" W x 1 3/16" H); consult factory for details. <sup>3</sup> Consult factory for details.						

**Mounting Diagrams**

Scale = 1 : 8

**Suspension Clips (SH)**

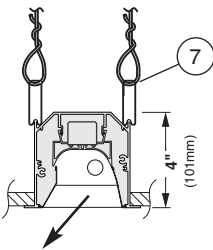

**Pre-installed Rod (TS)**

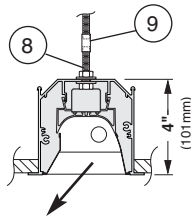

**Rotating Crossbars (RC)**

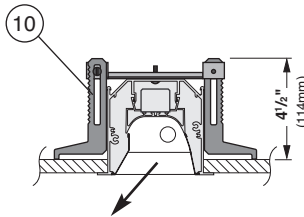

**Perimeter Mount (PM)**

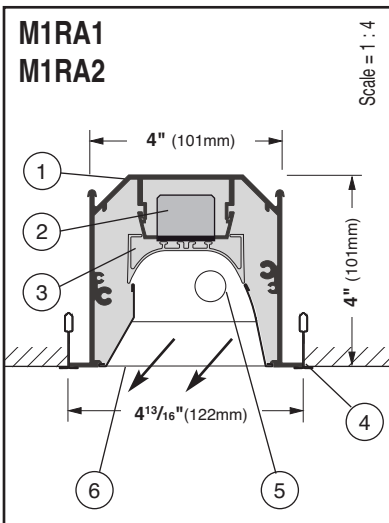
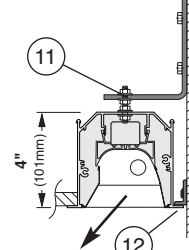

**1. Housing** - Continuous, 6063-T5 extruded aluminum profile up to 16 feet long. Joined with Connector Plus Joining System for ease of installation and to assure a uniform appearance.

**2. Ballast** - Electronic, high power factor, class "P," type "A" sound rating. Specify 120v, 277v, or 347v. Ballast is factory pre-wired with leads to one end of fixture. Consult factory for ballast options.

**3. Gear Tray** - Extruded aluminum, with white painted finish. Gear tray installed as a complete electrical unit and is held in place with knurled dress nuts. It is fully accessible from below ceiling.

**4. Flange** - 1/2" (12mm) wide flange runs full lengths of both sides and is part of the main extruded body. Specify continu-

ous flange (M1RA1) or flush end (M1RA2).

**5. Lamps** - As noted (by others). Other lamp lengths or wattages available, consult factory.

**6. Shielding** - Extruded, impact resistant acrylic snap in satine lens (SD) or Asymmetric Silky Specular Louver.

**7. Spring steel suspension clips** - Supplied two places, located nominally every 4 ft. Support wires Supplied and installed by others.

**8. Pre-installed 1" 1/4-20 Stud** - Attached to fixture every nominal 4 feet.

**9. Coupling and Threaded Rod to Structure** - Supplied and installed by others.

**10. Rotating Crossbars** - For inaccessible ceilings, adjustable for ceiling thicknesses from 1/4" to 2". Support required nominally every 4'.

**11. Steel Wall Bracket** and 1/4-20 rod supplied nominally every 4 ft. (Fasteners to wall and wall anchors by others)

**12. Aluminum Wall Bracket** - Secured to wall (fasteners and wall anchors by others) and runs entire length of fixture. Also supplied with width of fixtures when supplied with continuous flange. Allows for 1/8" gap between flange and wall to create shadow line allowing for unevenness of wall.

**Interior Luminaire Finish** - Standard interior colors are White (WH), Black (BK), and Silver (SV). Selux premium colors (SP) are available, please specify from your Selux color selection guide.

Selux Corp. © 2018  
TEL (845) 834-1400  
FAX (845) 834-1401  
www.selux.us  
M1RA1-0118-01 (ss-v6.1)



Union Made Affiliated  
with IBEW Local 363

In a continuing effort to offer the best product possible, we reserve the right to change, without notice, specifications or materials that in our opinion will not alter the function of the product. Specification sheets found at www.selux.us are the most recent versions and supercede all other printed or electronic versions.

# M100 Recessed Linear Fluorescent Asymmetrical Flanged Extrusion



## M1RA1 and M1RA2 Layout Dimensions

### M1RA1/M1RA2 Recessed - nominal 4 foot individual

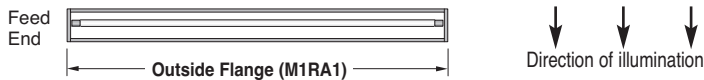

### M1RA1 Recessed - T-Bar Length - nominal 4 foot individual

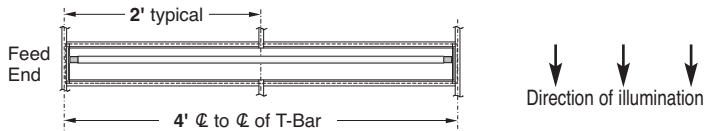

### M1RA1/M1RA2 Recessed - nominal 8 foot individual



### M1RA1 Recessed - T-Bar Length - nominal 8 foot individual

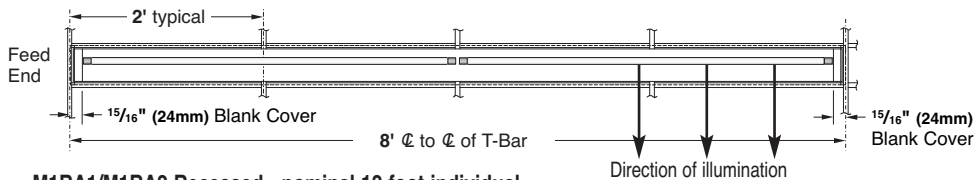

### M1RA1/M1RA2 Recessed - nominal 12 foot individual



### M1RA1 Recessed - T-Bar Length - nominal 12 foot individual

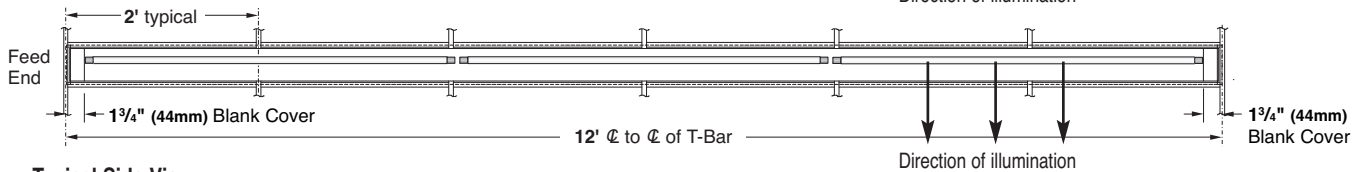

### Typical Side View

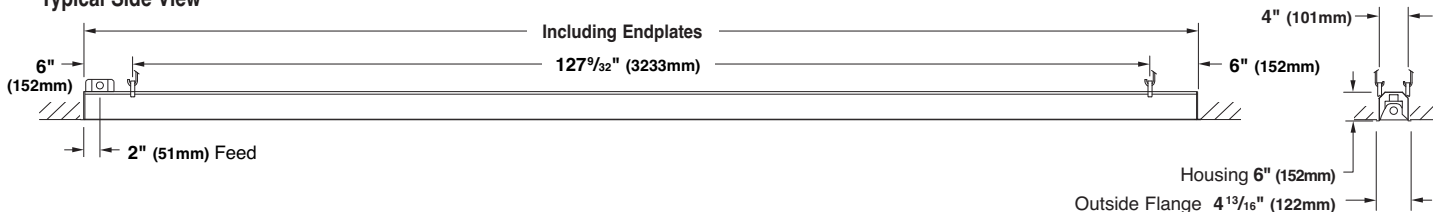

### Continuous Flange (M1RA1)



### Flush End (M1RA2)



Suspensions supplied spaced nominally every 4 feet.  
 Fixture supplied with 7/8 knockout located 2 5/16" from end in top of fixture.

	T5 (1 or 2 lamp)				T8 (1 lamp)	
	M1RA1/M1RA2 Including Endplates	M1RA1 Outside Flange	M1RA1/M1RA2 - TB Including Endplates	M1RA1 - TB Outside Flange	M1RA1/M1RA2 Including Endplates	M1RA1 Outside Flange
<b>4 foot individual</b>	46.78" (1188mm)	47.58" (1209mm)	47.03" (1195mm)	47.91" (1217mm)	48.33" (1228mm)	49.20" (1250mm)
<b>8 foot individual</b>	93.19" (2367mm)	94.00" (2388mm)	95.03" (2414mm)	95.91" (2436mm)	96.37" (2448mm)	97.24" (2470mm)
<b>12 foot individual</b>	139.59" (3546mm)	140.41" (3568mm)	143.03" (3633mm)	143.91" (3655mm)	144.41" (3668mm)	145.28" (3690mm)

For other lengths, lamping, continuous runs or configurations please specify overall length (in feet), accessories desired and sketch/drawing of configuration. Selux will detail project drawings upon order and supply submittal drawings for approval. Individual fixtures cannot be field joined. If you have any questions please contact Selux customer service or applications engineering for assistance (1-800-SELUX-CS).