

Saturn 4

selux



Project: _____

Type: _____ **Qty:** _____

SA4	—	—	—	—	—	—	—
Series	Optics	Mounting	Lamping	Finish	Voltage	Option	
—	—	—	—	—	—	—	
Pole Series	Height	Finish	Pole Options				
—	—	—	—				

Series	Optics	Mounting	Lamping			Finish	Voltage	Options
SA4 Saturn 4	MA Type III MTR 135 Refractor	1 Single	T6 Metal Halide	Metal Halide	HPS	WH White	120	HS ⁶ House Side Shield (180°)
	MS Type V MTR 135 Refractor	1A Single Arm Mount	H039T6 ^{1,2} 39w T6	H050 ³ 50w	S050 ³ 50w	BK Black	208	QR Quartz Restrike (40w max.)
	SP Type V Silver Louver	2 Double Wall Mount	H070T6 ² 70w T6	H070 70w	S070 70w	BZ Bronze	240	FS ³ Single Fusing PCT Photocell Tenon
	WP Type V White Louver		Compact Fluorescent			SV Silver	277	
	MR Type V MTR 150 Refractor			F042 ^{3,5} 42w Triple Tube	F070 ^{3,5} 70w Triple Tube	S100 100w	SP Specify Premium Color	347
<small>¹Only available in 120v and 277v ²Only available with MA and MS refractors ³Not available with 347v ⁴Not available with MR ⁵Only available with WP, SP and MR refractors ⁶Not available with MA</small>								

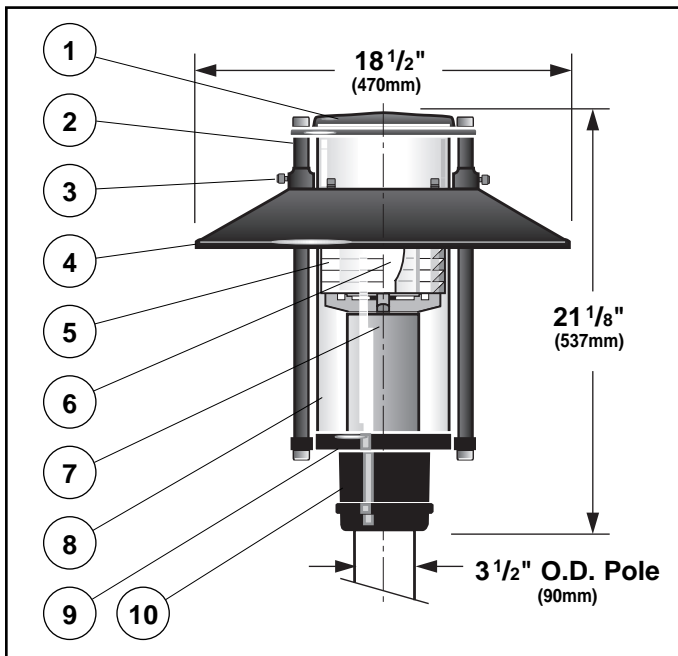

1. Fixture Cover - Aluminum cover with white painted interior for maximum fixture efficiency, has industrial felt gasketing for air circulation. Cover removes for lamp access.

2. Cover Support - Machined support connected to fixture cover with architectural Allen head nut detail.

3. Cover Set Screw - Two stainless steel, socket head cap screws provide attachment of fixture cover and support to 3/4" (19 mm) diameter connection rods. Loosening screws allows removal of fixture cover without tools.

4. Fixture Hood - Aluminum shade with white painted interior for maximum reflectivity.

5. Optics - Select Type III or Type V MTR 135 refractor; high pressure die-cast aluminum Type V silver or white louver; or Type V MTR 150 Refractor. Formed aluminum House-Side Shield available for all Type V Refractors. Clip-on prisms create Type III distribution for MA optics.

6. Lamp - Select one coated, base down, medium base ED-17 metal halide or high pressure sodium up to 100w; one G12 base T6 metal halide, up to 70w; or one 70w triple tube compact fluorescent. Lamp provided by others.

7. Electroblock - Extruded aluminum tubing houses core and coil ballast. Pulse rated porcelain, medium base socket is mounted to die-cast aluminum socket cup for maximum heat dissipation and is pre-wired to ballast. Socket cup attaches to electroblock with two stainless steel screws and is easily removable for ballast service. Consult factory for more detailed ballast information.

8. Diffuser - Clear, U.V. stabilized, acrylic with a minimum wall thickness of 0.125" (3mm).

9. Gasketing - Continuous molded neoprene gasket provides weatherproofing, dust, and insect control at diffuser base.

10. Pole Fitter - Self-leveling, die-cast aluminum, fitter base secured to pole with two, stainless steel, Allen head set screws. For 3 1/2" (90mm) O.D. poles.

Exterior Luminaire Finish - Selux utilizes a high quality Polyester Powder Coating. All Selux luminaires and poles are finished in our Tiger Drylac certified facility and undergo a five stage intensive pretreatment process where product is thoroughly cleaned, phosphated and sealed. Selux powder coated products provide excellent salt and humidity resistance as well as ultra violet resistance for color retention. All products are tested in accordance with test specifications for coatings from ASTM and PCI.

Standard exterior colors are White (WH), Black (BK), Bronze (BZ), and Silver (SV). Selux premium colors (SP) are available, please specify from your Selux color selection guide.

Selux Corp. © 2012
 TEL (845) 834-1400
 FAX (845) 834-1401
 www.selux.us
 SA4-0912-01 (ss-V4.61)

NRTL Listed (i.e. UL, CSA)

Union Made Affiliated
 with IBEW Local 363

In a continuing effort to offer the best product possible, we reserve the right to change, without notice, specifications or materials that in our opinion will not alter the function of the product. Specification sheets found at www.selux.us are the most recent versions and supercede all other printed or electronic versions.

Photometry

MTR 135 Refractor / 70w MH T6

Catalog # SA4-MA-1-H70T6
Report # SX-485AA4

- Dual optic function combines inner cylindrical lens with Fresnel type prisms.
- New generation MTR glass refractor with low glare and high efficiency.
- Maximum candela of 1463 at -62.5° from vertical.
- IES classification = Type III Non-Cutoff.

DOWNLOAD IES FILE:
<http://www.selux.us/web/files/exterior/SA4-MA-1-H70T6.zip>

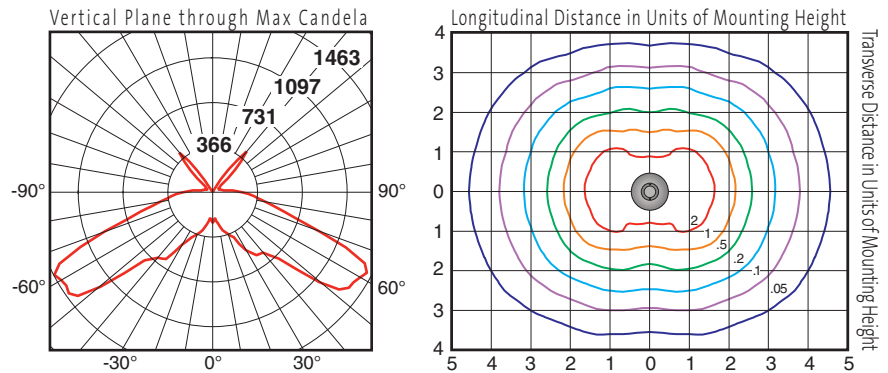

MTR 135 Refractor / 70w MH T6

Catalog # SA4-MS-1-H70T6
Report # SX-485AA5

- Dual optic function combines inner cylindrical lens with Fresnel type prisms.
- New generation MTR glass refractor with low glare and high efficiency.
- Maximum candela of 1112 at -62.5° from vertical.
- IES classification = Type V Non-Cutoff.

DOWNLOAD IES FILE:
<http://www.selux.us/web/files/exterior/SA4-MS-1-H70T6.zip>

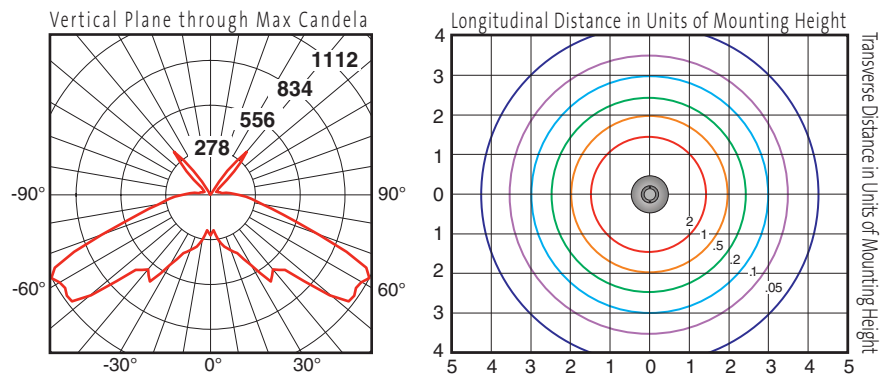

MTR 135 Refractor / 150w MH T6 / House Side Shield

Catalog # SA4-MS-1-H150T6-HS

Please consult factory.

H.I.D. Lamp Prorate Table (Clear, G12 base)		
T6 Metal Halide		
Wattage	Factor	Initial Lumens
39	0.50	3300
70	1.00	6600

Conversion Chart	
Values based on 10' mounting height.	
Mounting Height	Multiply
8'	1.12
10'	1.00
12'	0.91
14'	0.85
16'	0.79

Photometry

Silver Louver / 70w MH

Catalog # SA4-SP-1-H70
Report # SX-7682

- Mirror finish with prismatic underside shields light source and controls glare.
- Resulting “dark light” effect offers superior visual comfort.
- Maximum candela of 534 at 35° and -35° from vertical.
- IES classification = Type V Cutoff.

DOWNLOAD IES FILE:
<http://www.selux.us/web/files/exterior/SA4-SP-1-H70.zip>

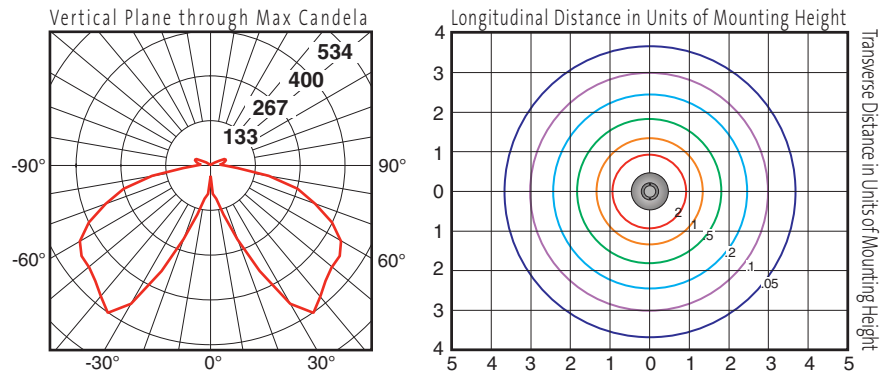

White Louver / 70w MH

Catalog # SA4-WP-1-H70
Report # SX-7800

- A se'lux variation of a classic louver design.
- Combines brightness control with a subtle luminance around the source.
- Maximum candela of 571 at 60° and -60° from vertical.
- IES classification = Type V Cutoff.

DOWNLOAD IES FILE:
<http://www.selux.us/web/files/exterior/SA4-WP-1-H70.zip>

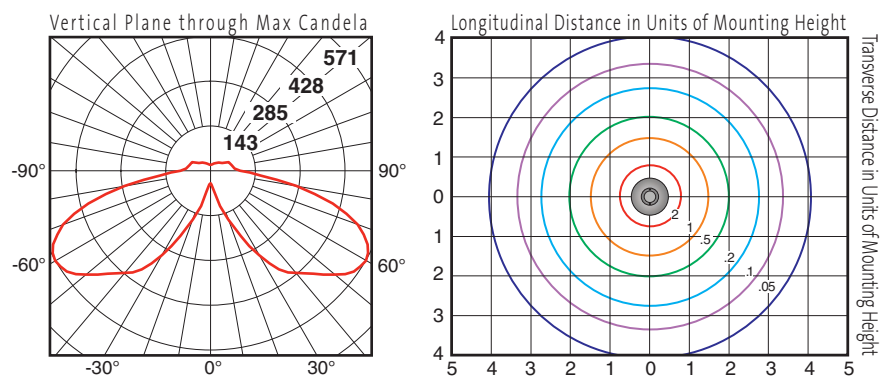

MTR 150 Refractor / 70w MH

Catalog # SA4-MR-1-H70
Report # SX-7683

- Innovative “multi-prisms for total reflection” incorporates light-bending characteristics of a prism.
- Directs light precisely with minimum intensity at critical viewing angles.
- Maximum candela of 607 at 55° and -55° from vertical.
- IES classification = Type V Semi-Cutoff.

DOWNLOAD IES FILE:
<http://www.selux.us/web/files/exterior/SA4-MR-1-H70.zip>

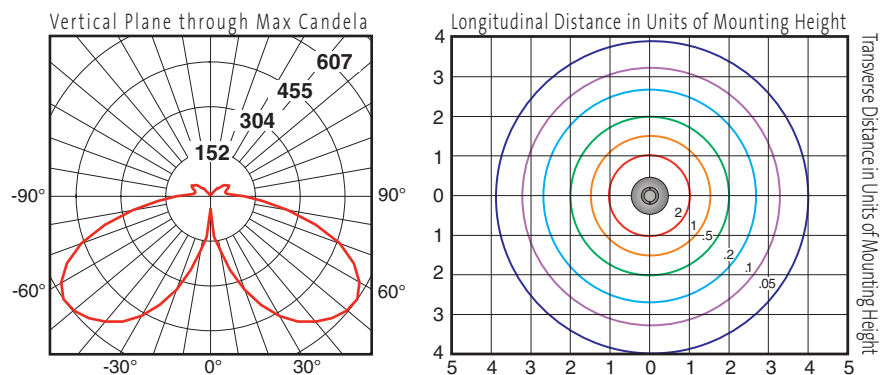

HID Lamp Prorate Table (ED-17 coated, medium base lamp)					
High Pressure Sodium			Metal Halide		
Wattage	Factor	Initial Lumens	Wattage	Factor	Initial Lumens
50	0.72	3800	50	0.60	3200
70	1.13	5950	70	1.00	5300
100	1.66	8800	100	1.60	8500
150	2.55	13500	150	2.51	13300

Conversion Chart	
Values based on 10' mounting height.	
Mounting Height	Multiply
8'	1.12
10'	1.00
12'	0.91
14'	0.85
16'	0.79

Mounting

Single

Die-cast aluminum fitter base secured to pole with two, stainless steel, Allen head set screws.

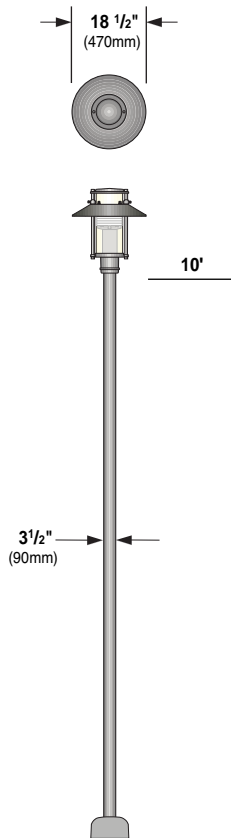

Single Arm Mount

Die-cast aluminum single luminaire mounting arm secured to pole with four stainless steel, Allen head set screws. Outer slip fitter for 3 1/2" tenon.

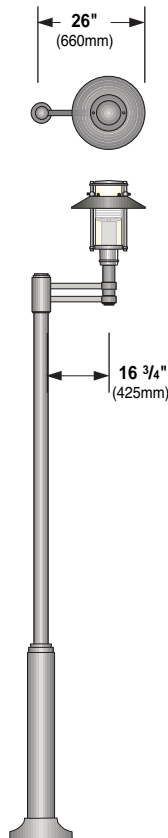

Double

Die-cast aluminum double luminaire mounting arm secured to pole with four stainless steel, Allen head set screws. Outer slip fitter for 3 1/2" (90mm) tenon.

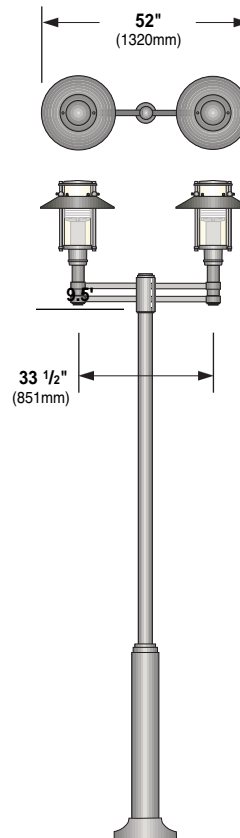

Wall

Die-cast aluminum double round wall mount arm. Secured to wall with 1/4" diameter threaded fasteners (by others).

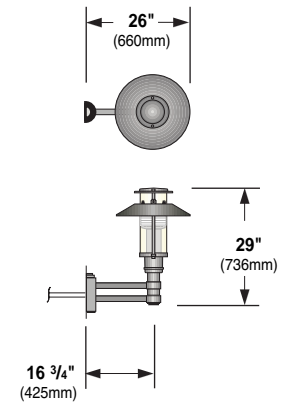

Wall Arm Mounting Detail

(Conduit and mounting hardware by others.)

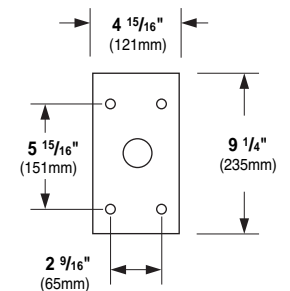

Pole Information

Refer to pole specification sheets for construction details, anchorage information and additional options.

A35 & S35
Round Straight Aluminum
& Round Straight Steel Poles

S635
Round Stepped
Steel Pole

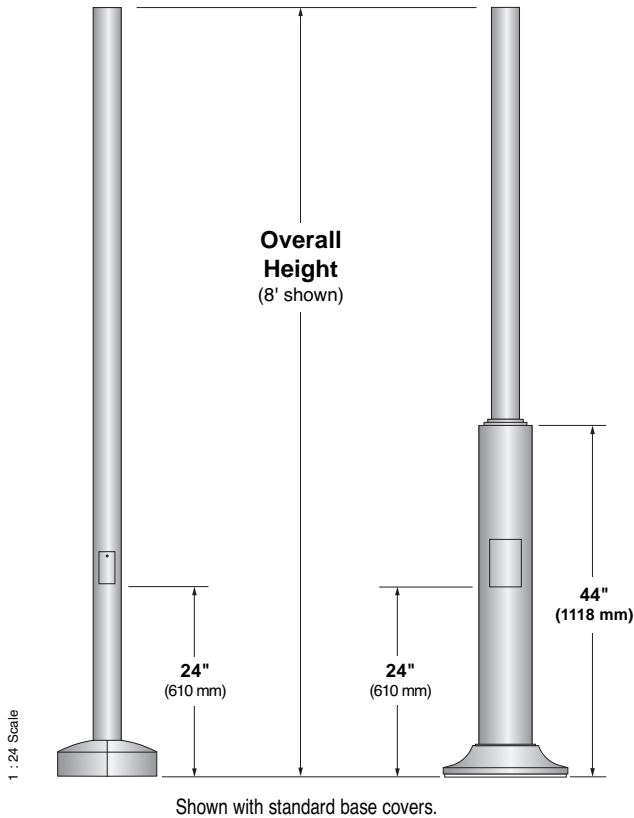

Base Cover Information

Refer to pole specification sheets for construction details, anchorage information and additional options.

Straight Poles (A35 & S35)
BC5 Standard Base Cover
Two-piece cast aluminum

Stepped Steel Pole (S635)
BC6 Standard Base Cover
One-piece cast aluminum

BC1 Optional Base Cover
(A35 & S35) One-piece cast aluminum

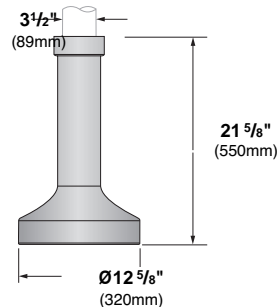
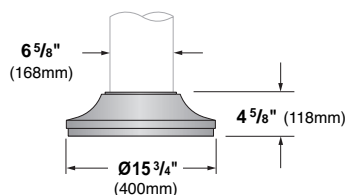
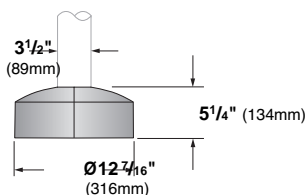

Pole Data Chart

Pole Series	Bolt Circle	EPA Information (ft ²)					Height	Finish	Options
		70 mph	80 mph	90 mph	100 mph	110 mph			
S635 3 1/2" Diameter Stepped Steel Pole	ø9"	57.6	44.3	34.6	27.5	22.8	8 8 ft.	WH White BK Black	BC1 Decorative Cast Aluminum Base Cover (for A35 & S35 poles only) REC GFCI Receptacle with weather-proof cover ¹ For PCT option, see p.1 ¹ Weatherproof cover intended for portable tools or other portable equipment connected to the outlet only when attended. For other requirements please consult factory.
A35 3 1/2" Diameter Straight Aluminum Pole	ø7 3/4"	16.1	12.2	9.4	7.3	5.9			
S35 3 1/2" Diameter Straight Steel Pole	ø7 3/4"	14.8	11.3	8.6	6.7	5.4			
S635 3 1/2" Diameter Stepped Steel Pole	ø9"	45.6	35.0	27.3	21.6	17.8	10 10 ft.	BZ Bronze SV Silver	
A35 3 1/2" Diameter Straight Aluminum Pole	ø7 3/4"	12.4	9.3	7.1	5.4	4.3			
S35 3 1/2" Diameter Straight Steel Pole	ø7 3/4"	11.4	8.6	6.5	4.9	3.9			
S635 3 1/2" Diameter Stepped Steel Pole	ø9"	37.6	28.7	22.3	17.5	14.4	12 12 ft.	SP Specify Premium Color	
A35 3 1/2" Diameter Straight Aluminum Pole	ø7 3/4"	9.9	7.3	5.4	4.0	3.1			
S35 3 1/2" Diameter Straight Steel Pole	ø7 3/4"	9.1	6.7	4.9	3.6	2.8			
S635 3 1/2" Diameter Stepped Steel Pole	ø9"	31.7	24.2	18.6	14.6	11.9	14 14 ft.		
A35 3 1/2" Diameter Straight Aluminum Pole	ø7 3/4"	8.0	5.8	4.2	3.0	2.2			
S35 3 1/2" Diameter Straight Steel Pole	ø7 3/4"	7.3	5.3	3.8	2.7	1.9			
S635 3 1/2" Diameter Stepped Steel Pole	ø9"	21.7	15.8	12.3	9.6	7.6	16 16 ft.		
A35 3 1/2" Diameter Straight Aluminum Pole	ø7 3/4"	4.9	3.2	2.2	1.4	0.8			
S35 3 1/2" Diameter Straight Steel Pole	ø7 3/4"	4.4	2.8	1.9	1.2	0.6			

¹Other pole configurations available, consult factory.

Effective Projected Area of Single Luminaire = 0.92 ft² (0.09m²) / Weight of Luminaire = 35.0 lbs (15.9kg)

Effective Projected Area of Double Luminaire = 2.37 ft² (0.22m²) / Weight of Double Luminaire (includes arms) = 94.0 lbs (42.6kg)

Optional Accessories

Photo Cell Tenon (PCT) - Button type photocell mounted in cast aluminum pole top tenon. Tenon has integral cast visor to prevent false start/stop cycle and can be oriented for optimum performance. Refer to fixture spec sheet to determine if this option is applicable.

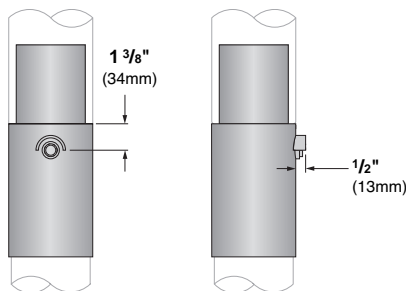

GFCI Receptacle (REC) - GFCI duplex receptacle with cast base bolted to pole and gasketed, provided with weather-proof, self-closing cover; located 36" (915mm) from base of pole, inline with hand-hole. Receptacle is intended only for portable tools or other portable equipment to be connected to outlet only when attended by operating personnel.

