

Discera 4

selux



Project: _____

Type: _____ **Qty:** _____

DSC4 - - - - -
 Series Mounting Lamping Optics Lamp Color Power Cord Length Finish Voltage Options

- - - - -
 Pole Series Height Finish Options

Series	Mounting	Lamping	Optics	Lamp Color	Power Cord Length	Finish	Voltage	Options
DSC4 Discera 4	S1 Single Short Arm	H039T6 39W T6	R3 Type III Distribution	830	12	WH White	120	PC Photocell
	S2 Double Short Arm @180°	H070T6 70W T6		842 ²	15	BK Black	240	
	L1 Single Long Arm		R5 Type V Distribution	942 ³	18	BZ Bronze	277	
	L2 Double Long Arm @180°			NOL	20	SV Silver		
	SW Short Arm Wall Mount				25	SP Specify Premium Color		
	LW Long Arm Wall Mount				XX ¹			
¹ Add length of arm and height of pole to determine power cord length. ² 39W only. ³ 70W only.								

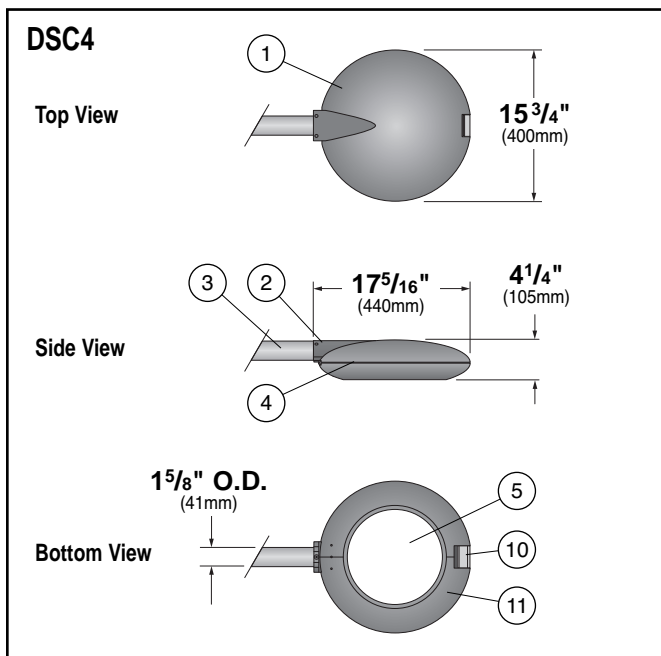

1. Luminaire Housing - Made from high pressure die-cast, low copper aluminum alloy.

2. Fitter - Cast fitter for direct connection to standard short and long arms.

3. Mounting Arm - Welded steel with powder coat finish.

4. Gasketing - (not shown) Silicone gasket provides seal at door and glass opening.

5. Glass Lens - Tempered and screened glass lens protects and seals optical chamber.

6. Reflector - (not shown) Precision formed aluminum reflector with Type III and Type V distributions. Fixture is IDA-Approved™ dark sky friendly.

7. Lamp - (not shown) 39 or 70 watt T6 metal halide.

8. Socket - (not shown) G12 base for T6 lamp.

9. Ballast - (not shown) Electronic ballast for Metal halide lamp, mounted to removable tray for ease of maintenance. All electrical connections are prewired.

10. Tool-less Latch - Tool-less steel latch for easy access to lamp chamber and maintenance.

11. Access Door - Lower casting features tempered glass lens and a stainless steel hinge that attaches to upper casting on mounting arm side. Other side is secured with tool-less latch for ease of maintenance.

Exterior Luminaire Finish - Selux utilizes a high quality Polyester Powder Coating. All Selux luminaires and poles are finished in our Tiger Drylac certified facility and undergo a five stage intensive pretreatment process where product is thoroughly cleaned, phosphated and sealed. Selux powder coated products provide excellent salt and humidity resistance as well as ultra violet resistance for color retention. All products are tested in accordance with test specifications for coatings from ASTM and PCI.

Standard exterior colors are White (WH), Black (BK), Bronze (BZ), and Silver (SV). SELUX premium colors (SP) are available, please specify from your Selux color selection guide.

Selux Corp. © 2012
 TEL (845) 834-1400
 FAX (845) 834-1401
 www.selux.us
 DSC4-0912-01 (ss-v2.62)

NRTL Listed (i.e. UL, CSA)
 Union Made Affiliated
 with IBEW Local 363



IP66 IK10

In a continuing effort to offer the best product possible, we reserve the right to change, without notice, specifications or materials that in our opinion will not alter the function of the product. Specification sheets found at www.selux.us are the most recent versions and supersede all other printed or electronic versions.

Photometry

R3 Reflector / 39W MH T6

Catalog # DSC4-1-R3-H039T6
Report # SX-3599-2

- Precision formed aluminum reflector to precisely control distribution.
- Ideal for applications demanding max. spacing.
- Maximum candela of 1107 at 70° from vertical.
- IES classification - Type III Full Cutoff.
- Mounting Height = 16' (4.9 m)
- IDA-Approved™ dark sky friendly.

DOWNLOAD IES FILE:
<http://www.selux.com/web/files/exterior/DSC4-1-R3-H039T6.zip>

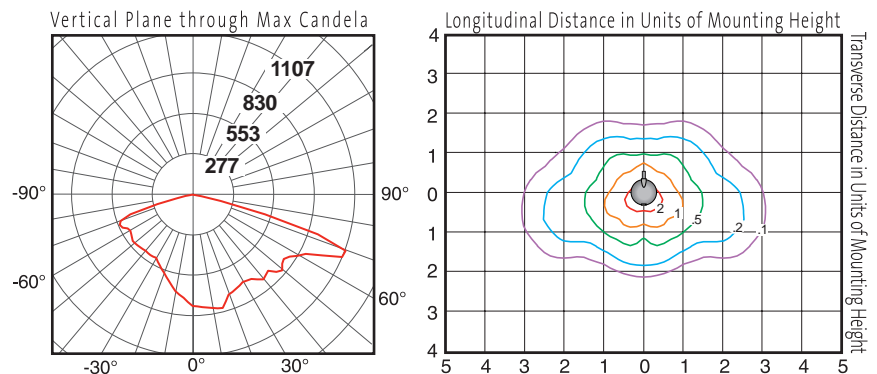

R3 Reflector / 70W MH T6

Catalog # DSC4-1-R3-H070T6
Report # SX-3599-1

- Precision formed aluminum reflector to precisely control distribution.
- Ideal for applications demanding max. spacing.
- Maximum candela of 2148 at 70° from vertical.
- IES classification - Type III Full Cutoff.
- Mounting Height = 16' (4.9 m)
- IDA-Approved™ dark sky friendly.

DOWNLOAD IES FILE:
<http://www.selux.com/web/files/exterior/DSC4-1-R3-H070T6.zip>

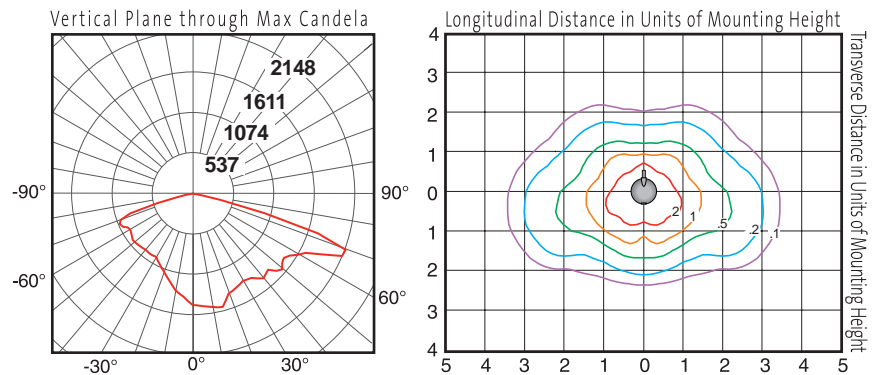

R5 Reflector / 39W MH T6

Catalog # DSC4-1-H039T6-R5
Report # SX-4753-1

- Symmetric formed aluminum reflector..
- Ideal for applications demanding max. spacing.
- Maximum candela of 808 at 0° from vertical.
- IES classification - Type V Full Cutoff.
- Mounting Height = 16' (4.9 m)
- IDA-Approved™ dark sky friendly.

DOWNLOAD IES FILE:
<http://www.selux.com/web/files/exterior/DSC4-S1-H039T6-R5.zip>

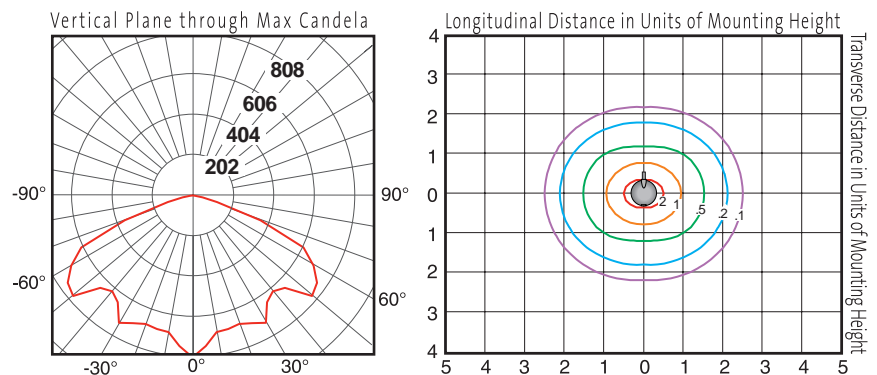

Photometry (cont'd)

R5 Reflector / 70W MH T6

Catalog # DSC4-S1-H070T6-R5
Report # SX-4753-1

- Symmetric formed aluminum reflector..
- Ideal for applications demanding max. spacing.
- Maximum candela of 1523 at 0° from vertical.
- IES classification - Type V Full Cutoff.
- Mounting Height = 16' (4.9 m)
- IDA-Approved™ dark sky friendly.

DOWNLOAD IES FILE:
<http://www.selux.com/web/files/exterior/DSC4-S1-H070T6-R5.zip>

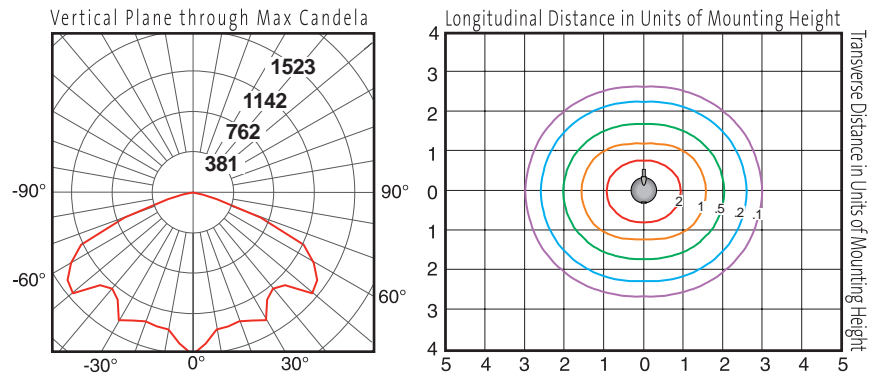

Conversion Chart	
Values based on 16' (4.9 m) mounting height.	
Mounting Height	Multiply
10' (3.0 m)	1.27
12' (3.7 m)	1.16
14' (4.3 m)	1.07
16' (4.9 m)	1.00
18' (5.5 m)	0.84

Short Arm Mounting

SW Short Wall Mount
EPA= .65 ft² (.13m²)
Weight= 22lbs. (10kg)

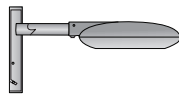
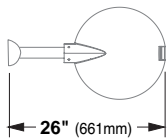

S1 Single Short Arm
EPA= .65 ft² (.13m²)
Weight= 22lbs. (10kg)

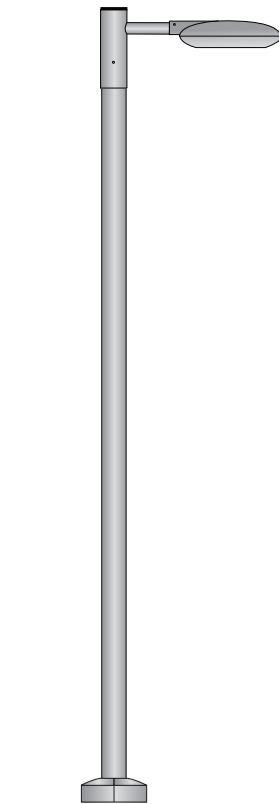
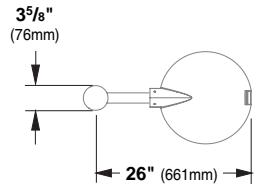

S2 Double Short Arm
EPA= 1.2 ft² (.37m²)
Weight= 44lbs. (21kg)

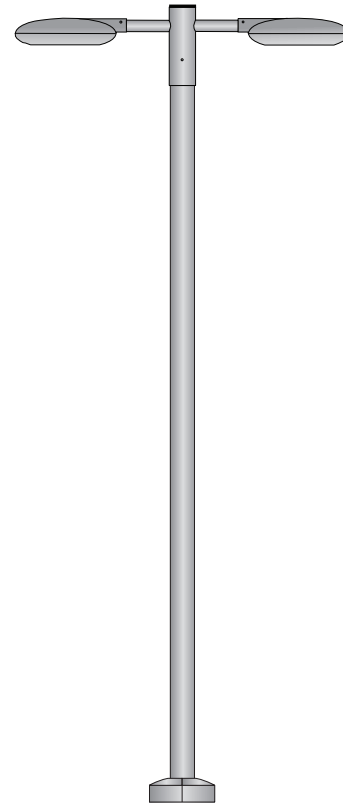
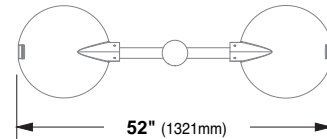

Long Arm Mounting

LW Long Wall Mount
EPA= .75 ft² (.13m²)
Weight= 22lbs. (10kg)

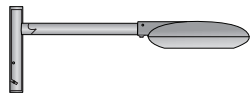
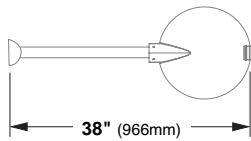

L1 Single Long Arm
EPA= .75 ft² (.13m²)
Weight= 22lbs. (10kg)

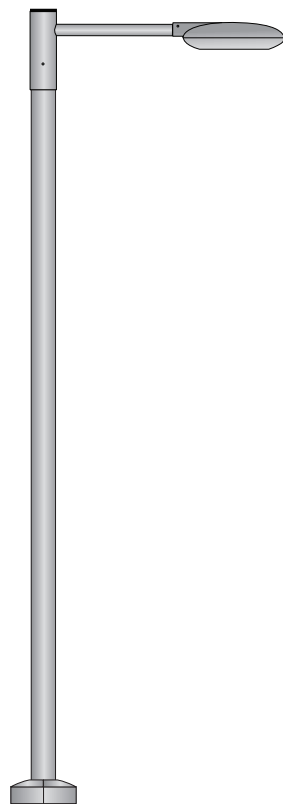
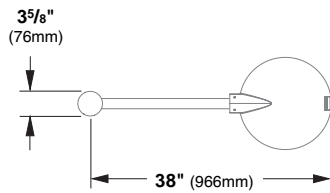

L2 Double Long Arm
EPA= 1.5 ft² (.46m²)
Weight= 44lbs. (21kg)

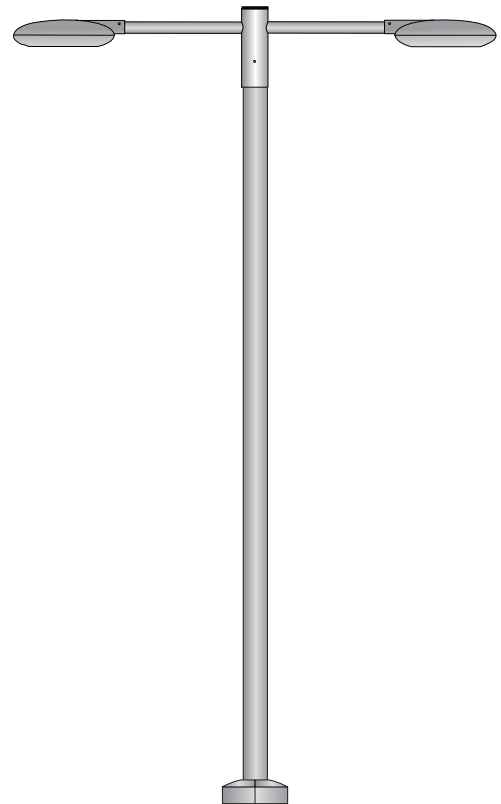
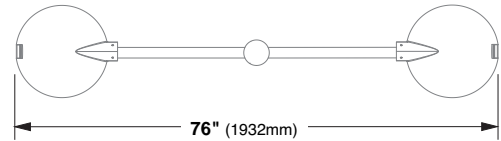

Pole Information

Refer to A35, S635, S35, AT535/635 and AT64/74 Pole specification sheets for construction details, anchorage information and additional options.

A35 & S35
Round Straight Aluminum
& Round Straight Steel Poles

S635
Round Stepped
Steel Pole

AT535/635 /64/74
Tapered Aluminum
Pole

Straight Poles (A35 & S35)
BC5 Standard Base Cover
Two-piece die cast aluminum

Stepped Steel Pole (S635)
BC6 Standard Base Cover
One-piece cast aluminum

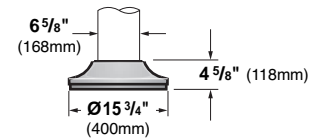
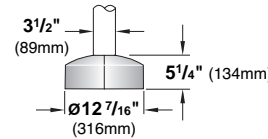
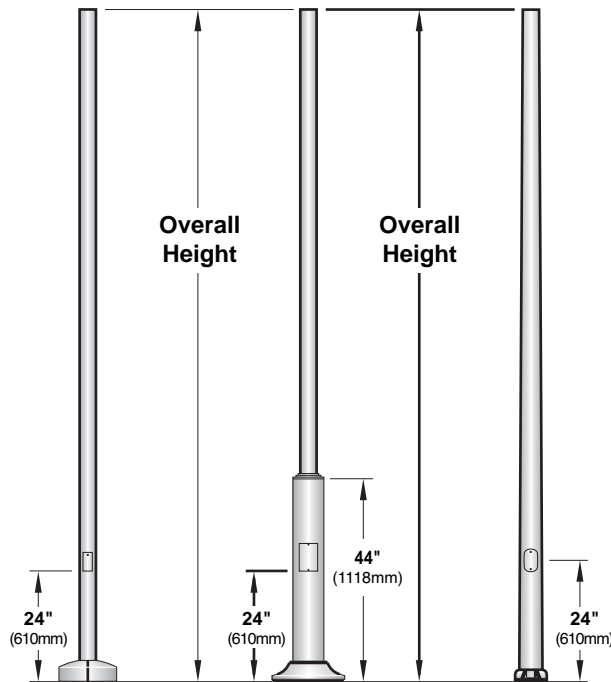

BC1 Optional Base Cover (A35 & S35)
One-piece die cast aluminum

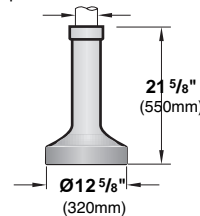

Optional Base Covers for Tapered Poles

Die cast aluminum, two piece field installable base covers

BC3 (AT535)

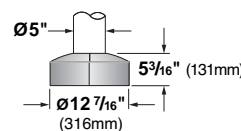

BC9 (AT635 / AT64)

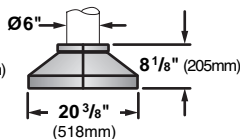

BC10 (AT74)

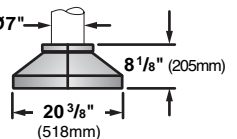

Pole Series	Bolt Circle	EPA Information (ft ²)					Height	Finish	Options
		70 mph	80 mph	90 mph	100 mph	110 mph			
S635 3 1/2" Diameter Stepped Steel Pole	9"	45.6	35.0	27.3	21.6	17.8	10 10 ft.	WH White	BC1 Die Cast Base Cover (A35 & S35 poles only)
A35 3 1/2" Dia. Straight Aluminum Pole	7 3/4"	12.4	9.3	7.1	5.4	4.3			
S35 3 1/2" Diameter Straight Steel Pole	7 3/4"	11.4	8.6	6.5	4.9	3.9	12 12 ft.	BK Black	BC3 Die Cast Base Cover (for AT535 poles only)
S635 3 1/2" Diameter Stepped Steel Pole	9"	37.6	28.7	22.3	17.5	14.4			
A35 3 1/2" Dia. Straight Aluminum Pole	7 3/4"	9.9	7.3	5.4	4.0	3.1	14 14 ft.	BZ Bronze	BC9 Die Cast Base Cover (for AT64 poles only)
S35 3 1/2" Diameter Straight Steel Pole	7 3/4"	9.1	6.7	4.9	3.6	2.8			
AT535 5" to 3 1/2" Tapered Aluminum Pole	8 1/2"	19.4	14.4	10.9	8.6	6.9	16 16 ft.	SV Silver	BC10 Die Cast Base Cover (for AT74 poles only)
S635 3 1/2" Diameter Stepped Steel Pole	9"	31.7	24.2	18.6	14.6	11.9			
A35 3 1/2" Dia. Straight Aluminum Pole	7 3/4"	8.0	5.8	4.2	3.0	2.2	18 18 ft.	SP Specify Premium Color	REC GFCI Receptacle with weather-proof cover*
S35 3 1/2" Diameter Straight Steel Pole	7 3/4"	7.3	5.3	3.8	2.7	1.9			
AT535 5" to 3 1/2" Tapered Aluminum Pole	8 1/2"	12.9	9.4	7.1	5.5	4.4	20 20 ft.	T35 3 1/2" Tennon (supplied with A64 poles for arm mounting)	For Photocell option, see p.1
S635 3 1/2" Diameter Stepped Steel Pole	9"	21.7	15.8	12.3	9.6	7.6			
A35 3 1/2" Dia. Straight Aluminum Pole	7 3/4"	4.9	3.2	2.2	1.4	0.8	18 18 ft.		
S35 3 1/2" Diameter Straight Steel Pole	7 3/4"	4.4	2.8	1.9	1.2	0.6			
AT535 5" to 3 1/2" Tapered Aluminum Pole	8 1/2"	10.7	7.7	5.6	4.2	3.3	18 18 ft.		
AT535 5" to 3 1/2" Tapered Aluminum Pole	8 1/2"	11.1	7.8	5.6	4.2	3.2			
AT64 6" to 4" Tapered Aluminum Pole	9 3/4"	15.7	11.5	8.7	6.9	5.5	20 20 ft.		
AT64 6" to 4" Tapered Aluminum Pole	9 3/4"	13.5	9.6	7.1	5.6	4.4			
AT74 7" to 4" Tapered Aluminum Pole	10 1/2"	20.3	15.0	11.4	9.0	7.3	20 20 ft.		

Other pole configurations available, consult factory.

Allowable EPA Calculated according to AASHTO 94 and include allowance for 1.3 gust factor.

See Mounting Configuration Pages for fixture, arm weight and EPA values.